

# The little **BIG BRAINS** that take care of the **COLD**



## A WIDE RANGE OF ELECTRONIC CONTROLLERS FOR:

- Temperature display and control.
  - The programming of compressor protection delays.
  - The programming of various types of defrost.
  - The programming of alarms with corresponding delays.
  - **Communications for PC control.**

**2 or 3 digits with decimal point.**

**Real time clock.**

**Digital input.**

**Acoustic alarm.**

**RS 485 Interface.**

**MODBUS communications protocol.**

**High performance compressor relay.**

**Up to 4 relays.**

**Up to 3 sensors.**

**PC control software.**

REF. **AKO-14423**  
NUM. 02192289  
S. Pere de Ribes, (Barcelona) Spain

PR DT °C  
PRG SET  
AKO

**GENERAL TECHNICAL SPECIFICATIONS**

Temperature range:	-50°C to +99°C
Sensor type:	<b>NTC</b>
Total accuracy (Sensor + controller):	±1°C
Sensor lead extension with cable <b>AKO-15586</b> :	Max. decrease 0.35°C for each 100m
Operating ambient temperature range:	5°C to 50°C
Storage temperature range:	-30°C to 70°C
Installation category:	II in accordance with the CEI 664 standard

**REFERENCE DIAGRAMS ON FOLLOWING PAGE**

The following diagrams represent concepts, each controller includes its diagram with terminal numbering for correct connection.

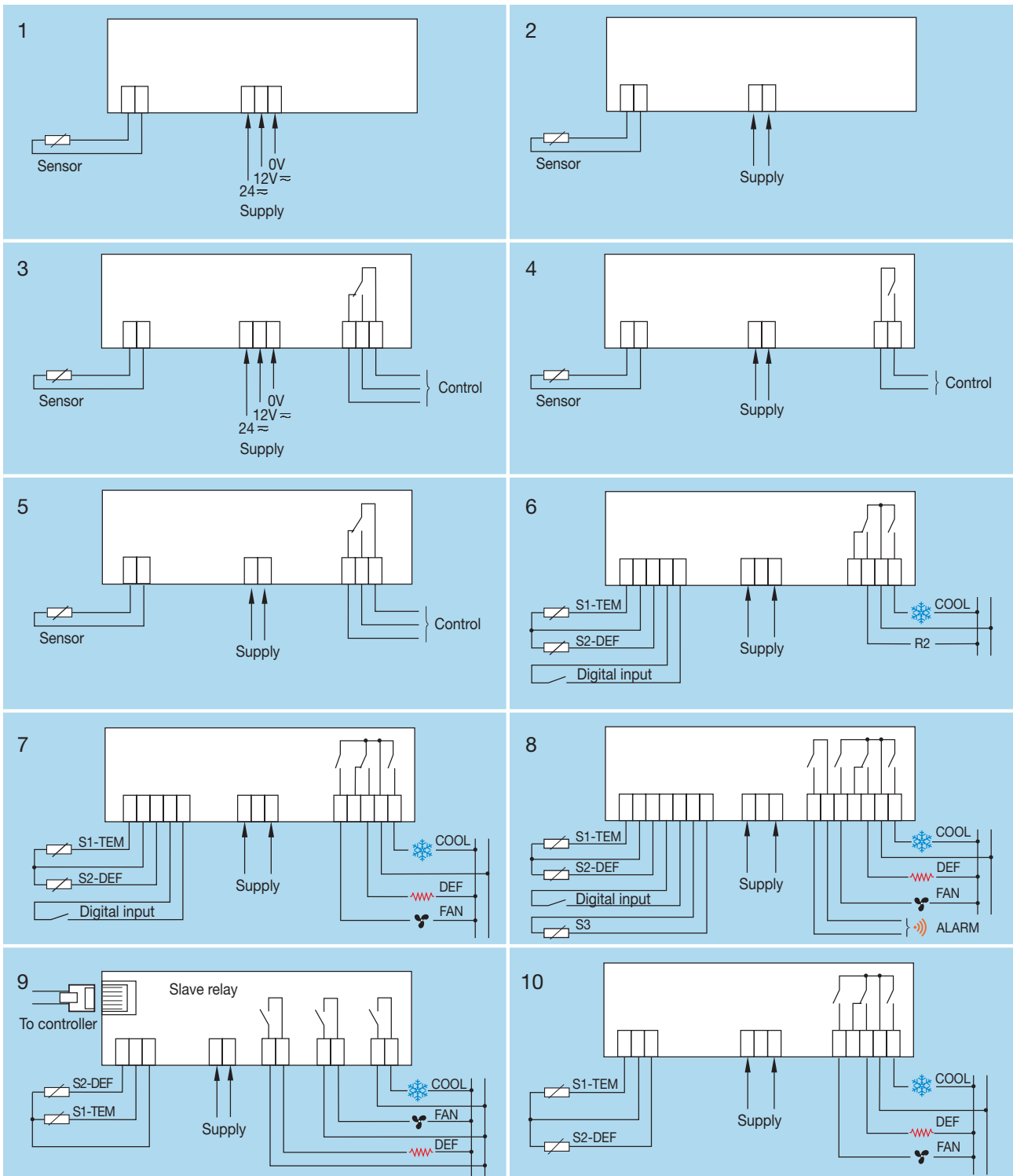

**REFERENCES AND SPECIFICATIONS**

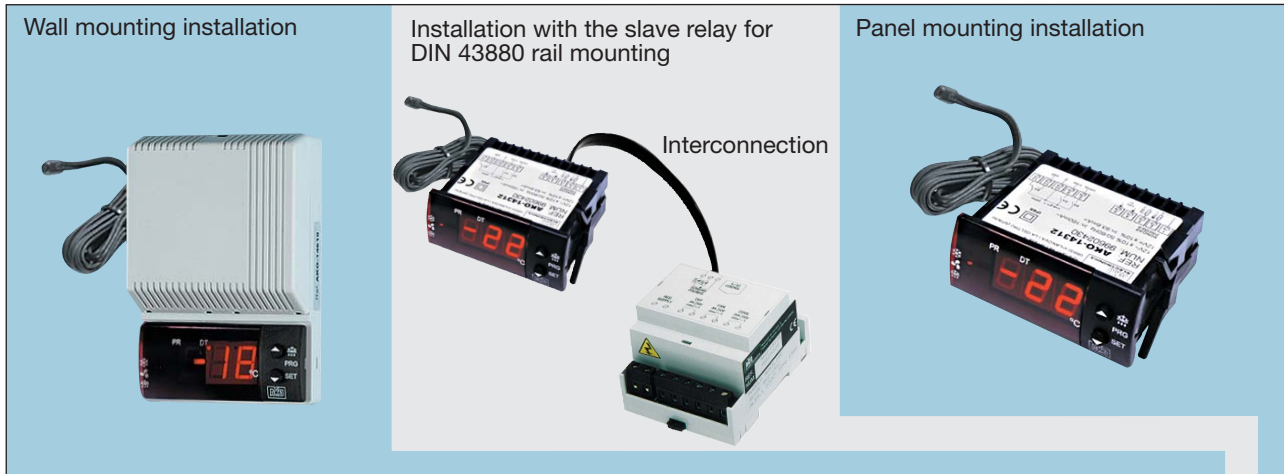

REFERENCES:	SPECIFICATIONS																
<b>AKO-14012</b> Thermometer 12/24V	1	•	•			•											•
<b>AKO-14023</b> Thermometer 230V	2	•	•			•											•
<b>AKO-14031</b> Thermometer 230V	2	•	•			•											•
<b>AKO-14112</b> 1 Relay 12/24V	3	•	•			•	•										•
<b>AKO-14123</b> 1 Relay 230V	4	•	•			•	•										•
<b>AKO-14128</b> 1 Relay 230V	5	•	•			•		•									•
<b>AKO-14129</b> 1 Relay 230V	4	•	•			•			•								•
<b>AKO-14212A</b> 2 Relays 12V	6	•	•	•	•	•			•					•			•
<b>AKO-14223</b> 2 Relays 230V	6	•	•	•	•	•			•					•			•
<b>AKO-14312B</b> 3 Relays 12V	7	•	•	•	•	•			•				•	•		•	•
<b>AKO-14323B</b> 3 Relays 230V	7	•	•	•	•	•			•				•	•		•	•
<b>AKO-14412</b> 4 Relays 12V	8	•	•	•	•	•			•				•	•	•	•	•
<b>AKO-14423</b> 4 Relays 230V	8	•	•	•	•	•			•				•	•	•	•	•
<b>AKO-14530+AKO-15128</b> 230V	9	•	•	•	•	•			•				•	•			•
<b>AKO-14602</b> Thermometer 230V	2	•	•			•											•
<b>AKO-14610</b> 1 Relay 230V	4	•	•			•	•										•
<b>AKO-14632</b> 3 Relays 230V	10	•	•	•	•	•			•				•	•			•

SPECIFICATIONS
Diagram for previous page
2 Digits, from -50°C to + 99°C
3 Digit decimal pt. from -49,9°C to 99,9°C
Sensor 1, NTC 1,5m included, non-adjustable
Sensor 1, NTC 1,5m included, adjustable
Sensor 2, NTC not included
Sensor 3, NTC not included
Power supply 12V $\approx$ $\pm$ 20%, 50/60Hz
Power supply 12/24V $\approx$ $\pm$ 10%, 50/60Hz
Power supply 230V $\sim$ $\pm$ 10%, 50/60Hz
Relay 1, Control (compressor) R16(4)A, 250V, cos $\varphi$ =1, SPST
Relay 1, Control (compressor) R 8(3)A, 250V, cos $\varphi$ =1, SPDT switch
Relay 1, Control (compressor) R16(4)A, 250V, cos $\varphi$ =1, SPST
Relay 1, Control (compressor) R16(4)A, 250V, cos $\varphi$ =1, SPDT switch
Relay 1, Control (compressor) R20(6)A, 250V, cos $\varphi$ =1, SPST
Relay 1, Control (compressor) R 30 max.18(5)A, 250V, cos $\varphi$ =1, SPST
Relay 2, Defrost or fans R 8A, 250V, cos $\varphi$ =1, SPDT switch
Relay 2, Defrost R 8A, 250V, cos $\varphi$ =1, SPDT switch
Relay 2, Defrost R 8A, 250V, cos $\varphi$ =1, SPST
Relay 3, Fan R 6A, 250V, cos $\varphi$ =1, SPST
Relay 3, Fan R 8A, 250V, cos $\varphi$ =1, SPST
Relay 4, Alarm R 6A, 250V, cos $\varphi$ =1, SPST
Internal acoustic alarm
Digital input (for voltage-free contacts)
Real time clock
Communications connector

## REFERENCES AND PROGRAMMABLE PARAMETERS

AKO-14412, AKO-14423	<b>4 relays, up to 3 sensors</b>	Compressor + Defrost + fans + Alarms								
AKO-14312B, AKO-14323B	<b>3 relays, up to 2 sensors</b>	Compressor + Defrost + fans								
AKO-14530, AKO-14632	<b>3 relays, up to 2 sensors</b>	Compressor + Defrost + fans								
AKO-14212A, AKO-14223	<b>2 relays, up to 2 sensors</b>	Compressor + Defrost by electric heat or air								
AKO-14112, AKO-14123, AKO-14128, AKO-14129, AKO-14610, AKO-14031	<b>1 relay, 1 sensor</b>	Defrost by compressor stop								
AKO-14031	<b>Adjustable thermometer</b>									
AKO-14012, AKO-14023, AKO-14602	<b>Thermometers</b>									
PARAMETERS		VALUES								
REFRIGERATION (Compressor)		Min.	Def.	Max.						
C0	Sensor 1 calibration (Offset)	-20°C	0°C	+20°C	•	•	•	•	•	•
C1	Sensor 1 differential (Hysteresis)	1°C	2°C	20°C		•	•	•	•	•
C2	Set point upper limit ( it cannot be set above this value)	xx°C	99°C	99°C		•	•	•	•	•
C3	Set point lower limit ( it cannot be set below this value)	-50°C	-50°C	xx°C		•	•	•	•	•
C4	Compressor protection delay type: 0=OFF/ON (from de last to switch-off) 1=ON (at swicht-on)	0	0	1		•	•	•	•	•
C5	Protection delay time (value for the option selected for parameter C4)	0min	0min	99min		•	•	•	•	•
C6	"COOL" relay status with faulty sensor 1 ( <b>1 relay</b> equipment) 0=OFF/ON (average last 24 hours) 1=OFF/ON (to C7 and C8 program)	0	0	1		•				
C6	"COOL" relay status with faulty sensor 1 ( <b>2, 3, 4, relay</b> equipment) 0=OFF 1=ON 2=OFF/ON (to C7 and C8 program)	0	1	2			•	•	•	•
C7	"COOL"relay (compressor) ON time in in case of sensor 1 failure if C7=0 and C8 ≠ 0, the relay will always be OFF de-energised	0min	10min	99min		•	•	•	•	•
C8	"COOL"relay (compressor) OFF time in in case of sensor 1 failure if C8=0 and C7 ≠ 0, the relay will always be ON energised	0min	5min	99min		•	•	•	•	•
DEFROST		Min.	Def.	Max.						
d0	Elapsed time between 2 starts ( <b>1 relay</b> equipment )	0h	1h	99h		•				
d0	Elapsed time between 2 starts ( <b>2, 3, 4, relays</b> equipment )	0h	6h	99h			•	•	•	•
d1	Maximum duration ( <b>1 relay</b> equipment )	0min	0min	99min		•				
d1	Maximum duration ( <b>2, 3, 4 relays</b> equipment )	0min	30min	99min			•	•	•	•
d2	Type of message during defrost: (1=display the defrost start temp.) (2=display the message dF or dEF)	0	2	2		•	•	•	•	•
d3	Maximum time of message added at end of defrost	0min	5min	99min		•	•	•	•	•
d4	Sensor 2 final defrost start temperature (if it is programmed in P4)	-50°C	8°C	99°C			•	•	•	•
d5	Defrost on equipment switch on: (0=no, first defrost according d0) (1=yes, first defrost according d6)	0	0	1			•	•	•	•
d6	Defrost start delay on equipment switch-off if d5=1	0min	0min	99min			•	•	•	•
d7	Defrost type: 0=Electric heat 1=Hot gas bypass <i>In 2-relay models for air defrosting, it is necessary to program F3</i>	0	0	1			•	•	•	•
d8	Time calculation between defrost periods: (0=Total real time) (1=Compressor operation sum)	0	0	1			•	•	•	•
d9	Drip time, compressor stop and FAN/R2 relay off when defrost ends <i>In 2-relay, R2 operates in all cases of P6</i>	0min	1min	99min			•	•	•	•
d10	1st defrost hour start time	0	off	23						•
d11	2nd defrost hour start time	0	off	23						•
d12	3rd defrost hour start time	0	off	23						•
d13	4th defrost hour start time	0	off	23						•
d14	5th defrost hour start time	0	off	23						•
d15	6th defrost hour start time	0	off	23						•
FANS (Evaporator)		Min.	Def.	Max.						
F0	Sensor 2 fan stop temperatures (if it is programmed in P4)	-50°C	4°C	99°C			•	•	•	•
F1	Sensor 2 (F0) differential for switching the FAN/R2 relay A1 and A2 Differential <i>In 2-relay models if P6=1 and P4=1</i>	1°C	2°C	50°C			•	•	•	•
F2	Stop fans if compressor stops? (0=no) (1=yes) <i>(In 2-relay if P6=1)</i>	0	0	1			•		•	•
F2	Stop fans if compressor stops? (0=yes) (1=no)	0	1	1				•		
F3	Fan status during defrost (0=stopped) (1=running)	0	0	1			•		•	•
F3	Fan status during defrost (0=running) (1=stopped)	0	1	1				•		
F4	Start-up delay after defrost (applicable if greater than d9)	0min	3min	99min			•	•	•	•
F5	Stop fan if door opens? (0=no) (1=yes)	0	0	1			•		•	•

## REFERENCES AND PROGRAMMABLE PARAMETERS

AKO-14412, AKO-14423	<b>4 relays, up to 3 sensors</b>	Compressor + Defrost + fans + Alarms							
AKO-14312B, AKO-14323B	<b>3 relays, up to 2 sensors</b>	Compressor + Defrost + fans							
AKO-14530, AKO-14632	<b>3 relays, up to 2 sensors</b>	Compressor + Defrost + fans							
AKO-14212A, AKO-14223	<b>2 relays, up to 2 sensors</b>	Compressor + Defrost by electric heat or air							
AKO-14112, AKO-14123, AKO-14128, AKO-14129, AKO-14610, AKO-14031	<b>1 relay, 1 sensor</b>	Defrost by compressor stop							
AKO-14012, AKO-14023, AKO-14602	<b>Adjustable thermometer</b>								
	<b>Thermometers</b>								
<b>PARAMETERS</b>		<b>VALUES</b>							
☺) <b>ALARMS (Visual, acoustic or relay)</b>		<b>Min.</b>	<b>Def.</b>	<b>Max.</b>					
<b>A1</b>	Maximum, °C above the Set Point in sensor 1	0=off	0=off	99°C		•	•	•	•
<b>A2</b>	Minimum, °C below the Set Point in sensor 1	0=off	0=off	99°C		•	•	•	•
<b>A3</b>	Start-up temperature alarm delay (if programmed in A1, A2)	0=off	0=off	120min		•	•	•	•
<b>A4</b>	Temp. alarm delay from end of defrost	0=off	0=off	99min		•	•	•	•
<b>A5</b>	Temp. alarm delay from the temperature at which they operate	0=off	30min	99min		•	•	•	•
<b>A6</b>	Temp. alarm delay from digital input disable (door if P9=1)	0=off	0=off	126min		•	•	•	•
<b>A7</b>	Temp. alarm delay from digital input enable (door if P9=1)	0=off	0=off	126min		•	•	•	•
<b>A8</b>	Alarms if defrost ends for maximum time: (0=no) (1=yes)	0	0	1		•	•	•	•
<b>A9</b>	Relay 4 alarm polarity configuration: (0=with alarm relay ON) (1=with alarm relay OFF)	0	0	1					•
<b>!</b>	<b>OTHER FEATURES</b>	<b>Min.</b>	<b>Def.</b>	<b>Max.</b>					
<b>P0</b>	Type of operation: (0=Cold) (1=Heat)	0	0	1		•			
<b>P1</b>	Relay for all function on power supply switch on	0min	0min	99min		•	•	•	•
<b>P2</b>	Programmed parameter block: (1=yes, block) (0=no, unblock)	0	0	1		•	•	•	•
<b>P3</b>	Initial parameters: (1= yes, configure to "Def" and exit progr.)	0	0	1		•	•	•	•
<b>P4</b>	Connected sensors: (1=Sensor 1) (2=Sensor 1+Sensor 2) (3=Sensor 1 +Sensor 2 +Sensor 3)	1	2	3		•		•	•
<b>P4</b>	Connected sensors: (0=Sensor 1) (1=Sensor 1+Sensor 2)	0	1	1				•	
<b>P5</b>	Address for equipment with communication	0	0	126		•		•	•
<b>P6</b>	Relay 2 (R2) function: (0=defrost by electric heat) (1=fan control)	0	0	1		•			
<b>P7</b>	Temperature display mode: (0=Whole) (1=One decimal)	0	0	1		•		•	•
<b>P8</b>	Displayed sensor: (1=Sensor 1) (2=Sensor 2) (3=Sensor 3)	1	1	3		•		•	•
<b>P9</b>	Digital input configuration: (0=disabled) (1=door) (2=external alarm)	0	0	2		•		•	•
<b>P10</b>	Contact with close door or enabled alarm: (0=open) (1=closed)	0	0	1		•		•	•
<b>P11</b>	Transfer parameters: (0=disabled) (1=send) (2=receive)	0	0	2		•		•	•
<b>P12</b>	Program version (information)					•		•	•
<b>r1</b>	Clock configuration, Hour	0	x	23					•
<b>r2</b>	Clock configuration, Minute	0	x	59					•
<b>EP</b>	Exit programming					•	•	•	•
<b>MESSAGES</b>									
<b>dF</b>	<b>Fixed</b> - Indicates defrost is being carried out. In order to display "dF" or "dEF" when defrosting, it is essential that parameter d2 is set to option 2.					•	•	•	•
<b>AE</b>	<b>Intermittent with temperature</b> - External alarm (if P9=2)					•		•	•
<b>AH</b>	<b>Intermittent with temperature</b> - The sensor 1 temperature is between 99°C < temp. < 110°C or exceeds the parameter temperature programmed in C2					•			
<b>AH</b>	<b>Intermittent with temperature</b> - The sensor 1 temperature exceeds that programmed in A1					•	•	•	•
<b>AL</b>	<b>Intermittent with temperature</b> - The sensor 1 temperature is lower than that programmed in C3					•			
<b>AL</b>	<b>Intermittent with temperature</b> - The sensor 1 temperature is lower than that programmed in A2					•	•	•	•
<b>Ar</b>	<b>Intermittent with temperature</b> - Low-charge clock battery or non-programmed clock alarm								•
<b>E1</b>	Sensor 1 failure (open circuit, crossed, temp. > 110°C ó temp. < -55°C)					•	•	•	•
<b>E2</b>	Sensor 2 failure (open circuit, crossed, temp. > 110°C ó temp. < -55°C)					•	•	•	•
<b>E3</b>	Sensor 3 failure (open circuit, crossed, temp. > 110°C ó temp. < -55°C)								•
<b>E5</b>	Incorrect sensor configuration ( see P4, P8 )					•		•	•
<b>EE</b>	Memory failure					•	•	•	•
	Messages E2 and E3 are displayed if P4 has been suitable programmed. Equipment operation under these conditions is the same as if P4 had been programmed with option 1					•	•	•	•

## FRONT PANEL FUNCTIONS

### ▲ Increase button

- When pressed for at least 5 seconds, a manual defrost is started with programmed duration.
- In programming, it increases the value being displayed.
- In 2, 3 and 4 relay models, it cancels the alarms, but they remain displayed.

### ▼ Decrease button

- When pressed for at least 5 seconds, it displays the SET POINT temperature value.
- In programming, it decreases the value being displayed.
- In 2, 3 and 4 relay models, it cancels the alarms, but they remain displayed.

### MODELS WITH 1 RELAY:

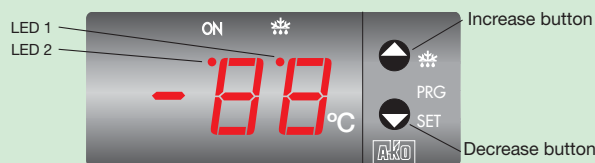

**LED 1 Permanent:** Indicates defrost in operation.

**LED 2 Permanent:** Indicates compressor relay is ON.

**Flashing:** Set Point or parameter programming phase.

### MODELS WITH 2, 3 AND 4 RELAYS:

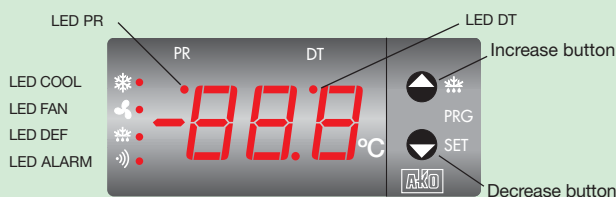

**LED DT Permanent:** Indicates last defrost ended by time.

**LED PR Flashing:** Set Point or parameter programming phase.

**LED COOL Permanent:** Cooling relay COOL (compressor) energised.

**Flashing:** Because of the temperature detected by Sensor 1 (TEM), the COOL relay should be energised, but is not due to a programmed parameter.

**LED FAN Permanent:** FAN relay energised.  
**Flashing:** Because of the temperature detected by Sensor 2 (DEF), the FAN relay should be energised, but is not due to a programmed parameter

**LED DEF Permanent:** Indicates defrost in operation.

**LED ALARM Permanent:** ALARM relay energised (or acoustic alarm).  
**Flashing:** Alarm detected, relay de-energised, but display maintained.

## PROGRAMMING

### ADJUSTING THE SET POINT TEMPERATURE

The factory default value is 0°C.

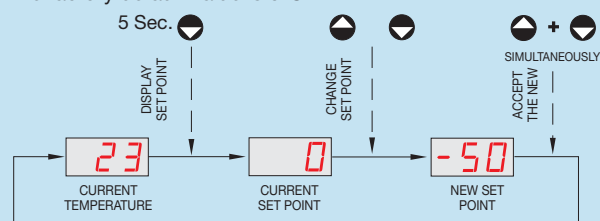

- When the ▲ key is pressed for at least 5 seconds, it displays the current SET POINT and LED 2/PR flashes.

- Pressing the ▲ or ▼ keys permits the SET POINT to be adjusted to the required value.

- Pressing the ▲ and ▼ keys simultaneously sets the new value. When this operation is carried out, the display will return to the current temperature and LED 2/PR will cease flashing.

### Adjusting thermometer ref. AKO-14031 calibration

Pressing the two keys simultaneously for at least 10 seconds displays the calibration value (default = 0°C). Each press of the keys ▲ or ▼ will change the temperature display by 1°C between -20°C and +20°C. The two keys should be pressed simultaneously again in order to accept the new value.

### PARAMETERS

The parameters should only be programmed or modified by personnel who are fully conversant with the operation and possibilities of the equipment.

#### LEVEL 1 PARAMETERS:

- Pressing the ▲ and ▼ keys simultaneously for at least 10 seconds will cause LED 2/PR to indicate the programming phase and the first parameter "C0" will appear on the display.

- Pressing the ▲ key accesses the next parameter and the ▼ key will produce a return to the previous parameter.

- If the ▲ and ▼ keys are simultaneously pressed in the last parameter "EP", the controller will return to the temperature display situation and the LED 2/PR will cease to indicate the programming phase

#### LEVEL 2 VALUES:

- In order to display the current value of any parameter, the keys ▲ and ▼ keys should be simultaneously pressed with the required parameter selected. Once it is displayed, it can be modified by pressing the ▲ or ▼ keys.

- Pressing the ▲ and ▼ keys simultaneously sets the new value. When this operation is performed, the programming returns to Level 1 (parameters).

NOTE: If a key is not pressed for 25 seconds in any of the previous steps, then the equipment will automatically return to the current temperature display situation without modifying any of the values.

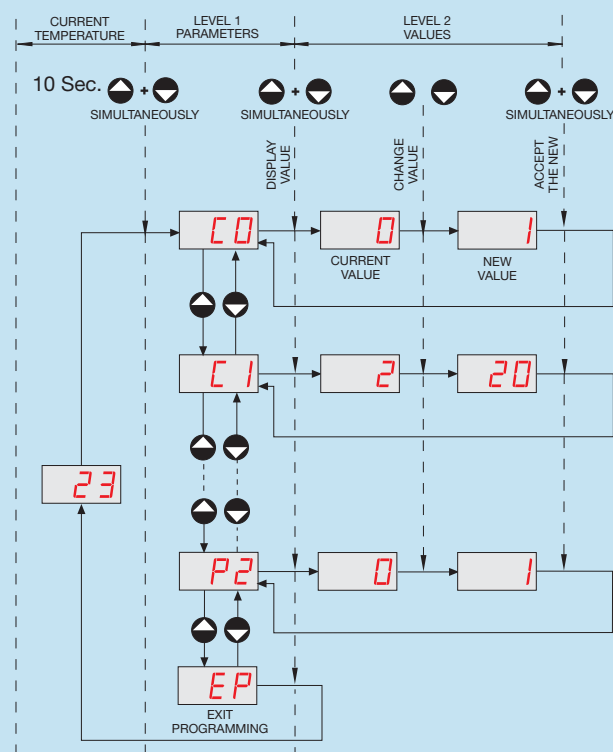

## PARAMETERS TRANSFER SERVERS

### AKO-14911

This is connected by means of the **AKO-80018**, 230/12V, to the power supply and it is programmed with the parameters that can be transferred to the **AKO-14112** and **AKO-14123** units without these having to be powered.

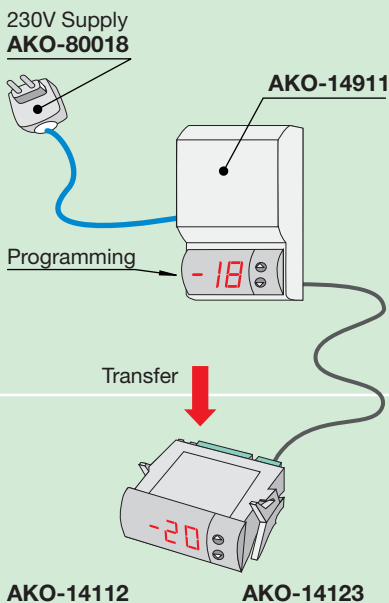

### AKO-14916

Tabletop server which is connected by means of the **AKO-80018**, 230/12V, to the power supply. Permit to transfer parameters previously recorded in one server **AKO-14918**, to the other controllers with communication connector without these having to be powered.

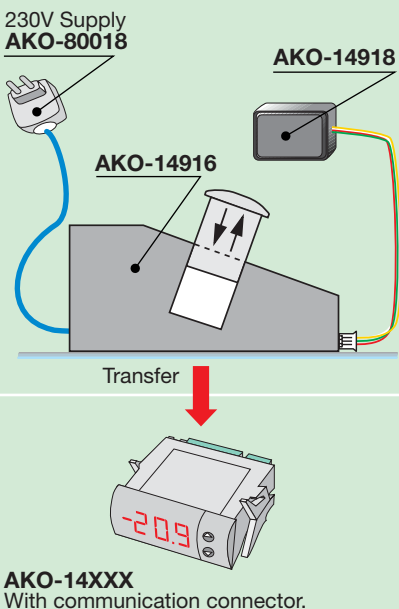

### AKO-14918

A portable server without supply to which, the parameters programmed in powered units with communication connector can be copied. The parameters may then be transferred from the server to other identical powered units.

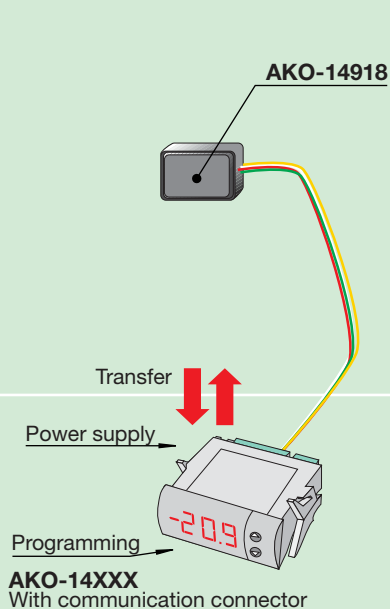

## COMMUNICATION

The units provided with a communications connector, permit data transmission and reception using the standard **MODBUS** protocol and to carry out management from PC software. This makes a centralised system for display, logging, alarms, remote teleprocessing ...

### AKO-5003

Software for controllers and data loggers using a PC type computer.

#### On request software with:

- External alarms by telephone, fax or internet.
- Display boards.
- Power management.
- PLC management.
- Remote teleprocessing.

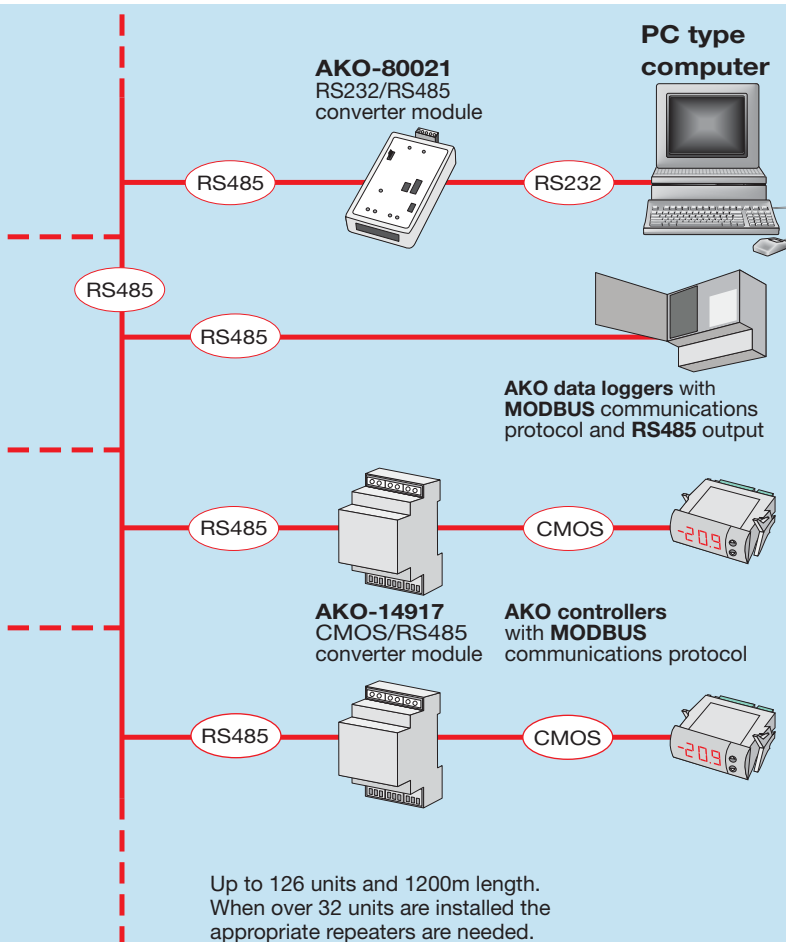

Up to 126 units and 1200m length.  
When over 32 units are installed the appropriate repeaters are needed.

## ACCESSORIES

### Front protector



**AKO-14910**  
In transparent plastic for panel mounting units

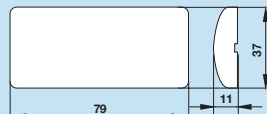

### Sheath for housing sensors in tanks



**AKO-155908**  
Stainless steel material

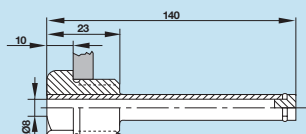

### Power supply transformer



**AKO-15590**  
120-230/12V, 3VA

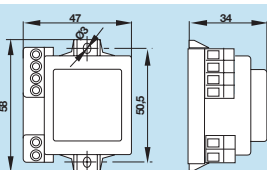

### Power supply converter



**AKO-15589**  
14 to 30V~/12V=, 6VA

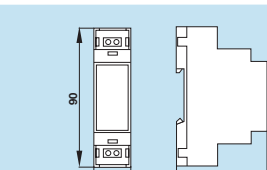

### Sensor extension cable



**AKO-15586**  
3 x 0,5mm<sup>2</sup> cable with insulation + copper braid + PVC sheath.

### NTC Sensors

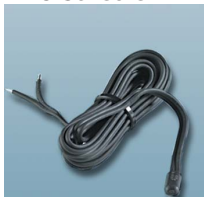

**AKO-14901** L=1,5m  
**AKO-14902** L=2,0m  
**AKO-14903** L=3,0m  
**AKO-14906** L=6,0m

Modified polyolefin sheath and cable

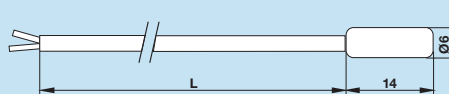

### Tapered probe NTC sensor



**AKO-14915**  
Stainless steel tapered probe with 3m silicone cable

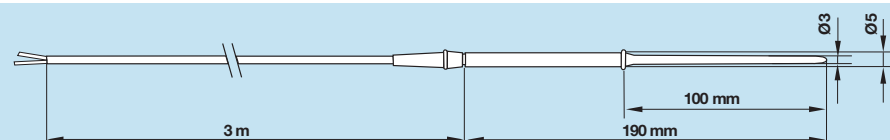

## DIMENSIONS

### Panel mounting

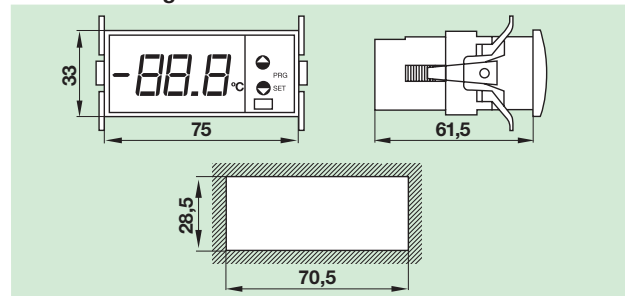

### Interconnection

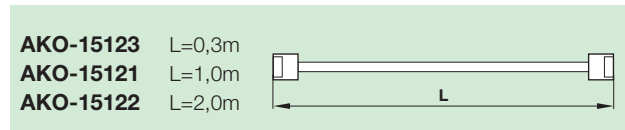

### DIN rail slave relay

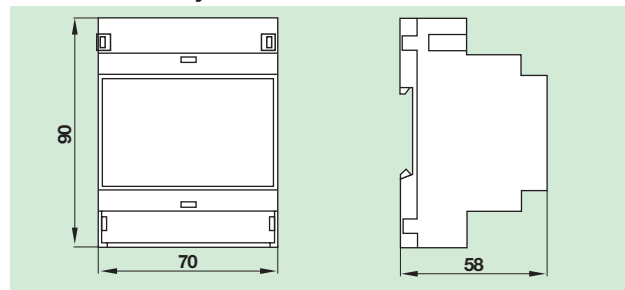

### Wall mounting

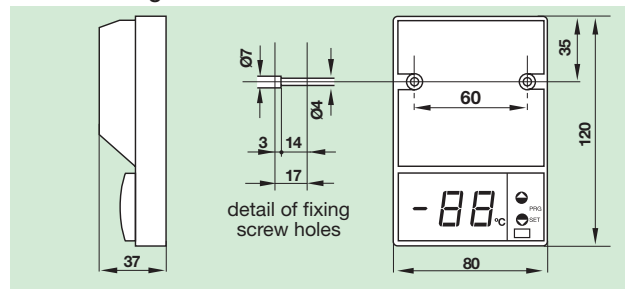

## AKO Electromecànica, S.A.L.

Av. Roquetes, 30-38  
08812 S. PERE DE RIBES (Barcelona)  
Tel. (34) 938 142 700  
Fax (34) 938 934 054  
Internet: www.ako.es  
e-mail: ako@ako.es

✉ Apartado (P.O. Box), 5  
08800 VILANOVA I LA GELTRÚ (Spain)