

Product Ranges

- Castel Cool

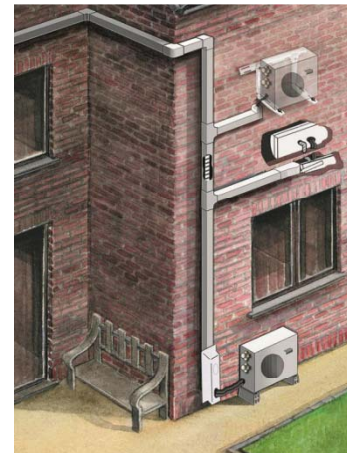

- Castel Door Hardware



- Castel
Air Conditioning Acc.

- Castel Door Hardware

- The Accessories you need to manufacture your door!

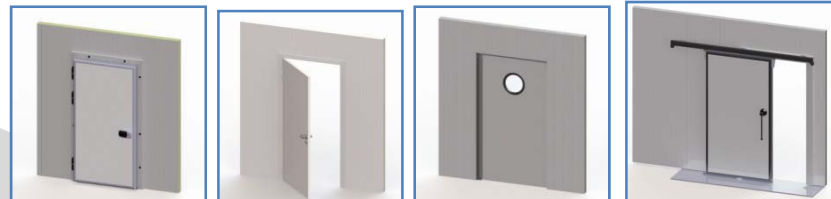

• For Overlapping Doors



• For Overlapping Doors



50-150 MM
DOOR LEAF



FOR
LEFT/RIGHT
DOORS



WITH
OR
WITHOUT



POSITIVE /
NEGATIVE
TEMP.

- For Overlapping Doors

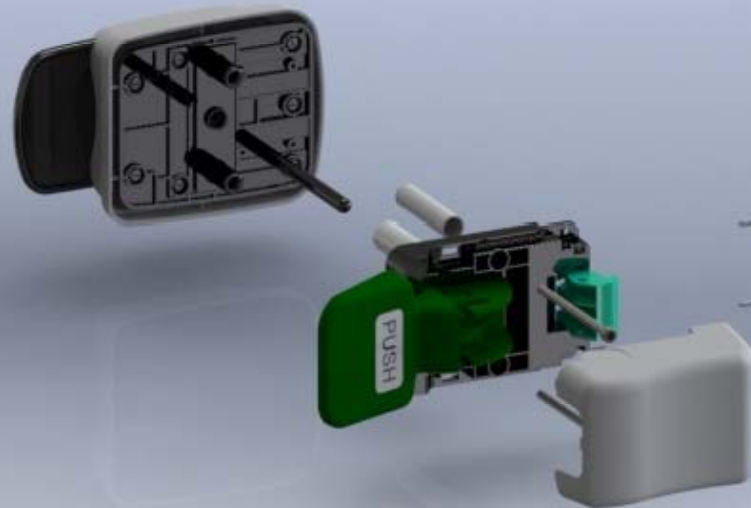

• For Office Doors



Stainless Steel

•For Overlapping Doors



•Series 4100



•Serie s 4110
Adjustable



•Series 4120
Adjustable



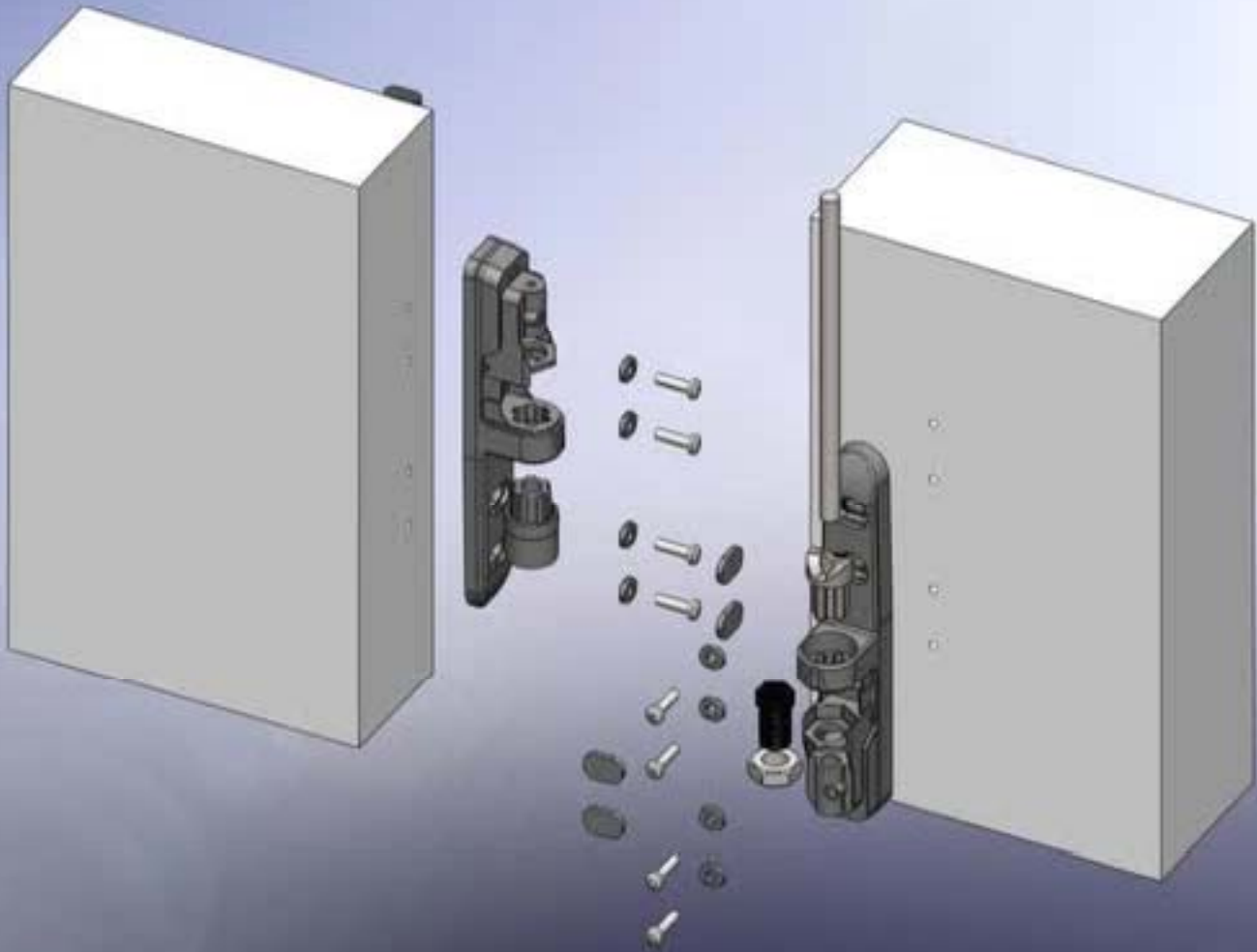

•For Office Doors

Lift-off



•Series 4130

Flag Hinge

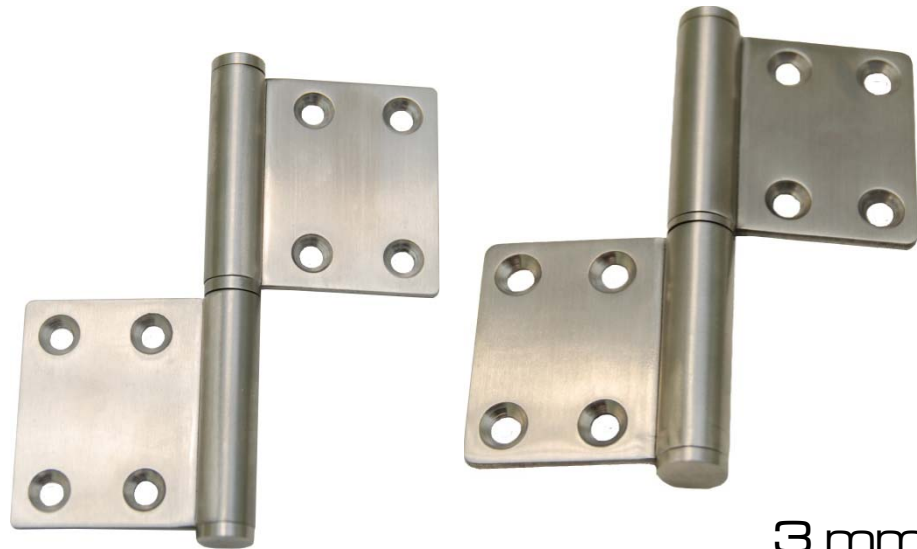

2,5 mm

•Serie s 413x

3 mm

Stainless Steel

• For Swing Doors

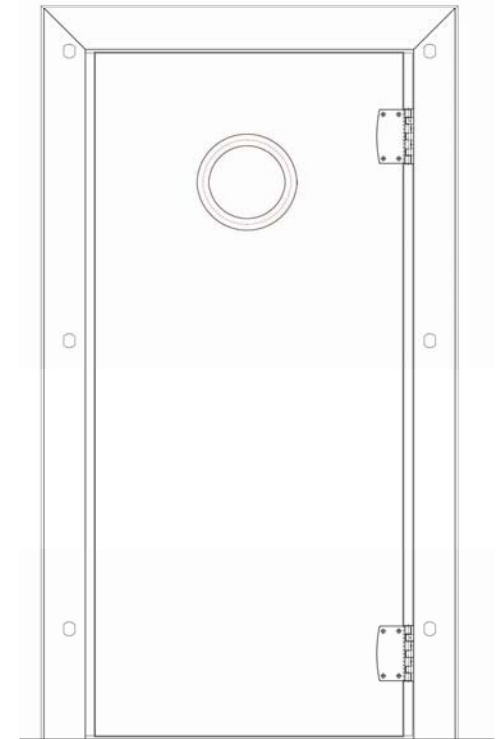
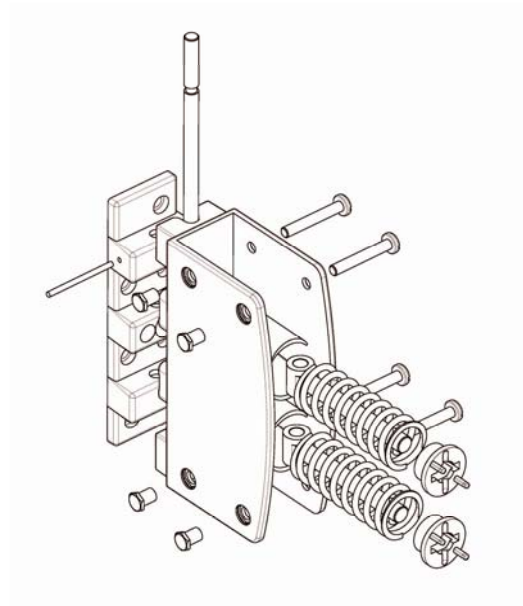

40 MM
(≤ 40 MM)
DOOR LEAF



POSITIVE
TEMP.



Occlus

The ultimate "push pull"
hinge system

• For Swing Doors

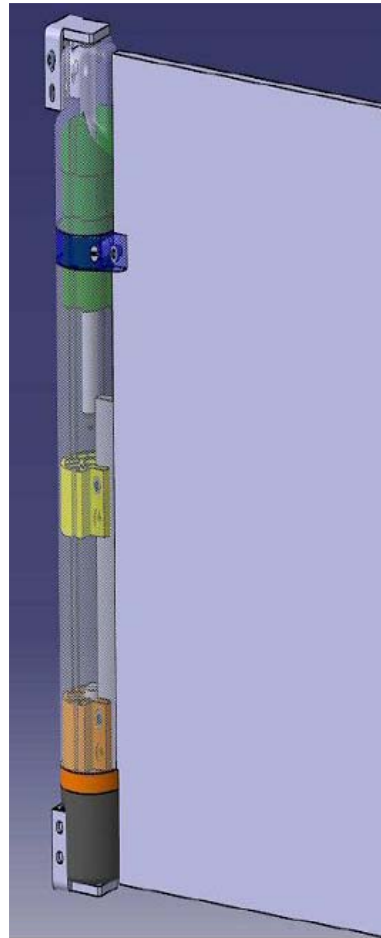

Serie 5100

Stainless Steel

Castel engineering NV

- For Overlapping, Sliding & Hinged Doors

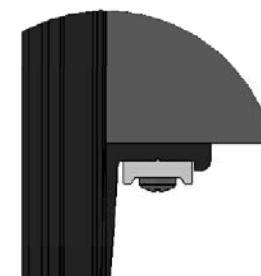
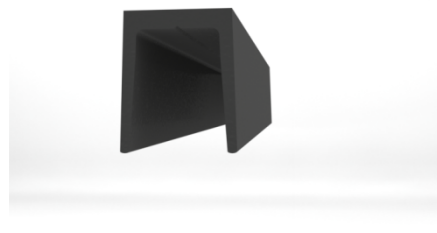
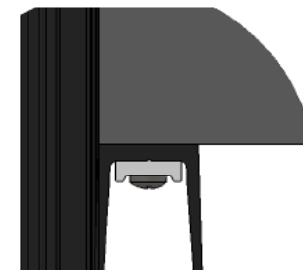

- For Overlapping Hinged doors



•Serie 2200

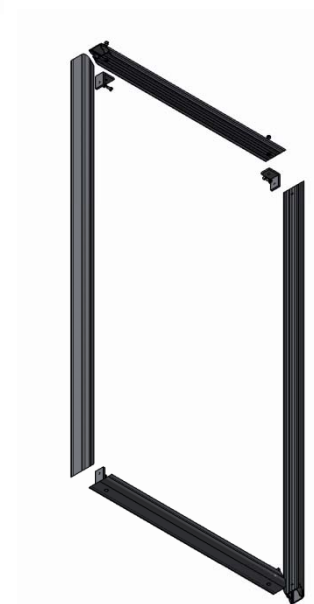
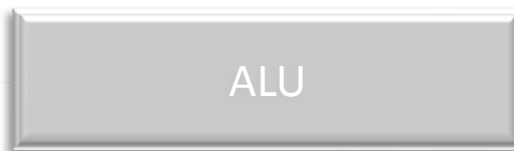
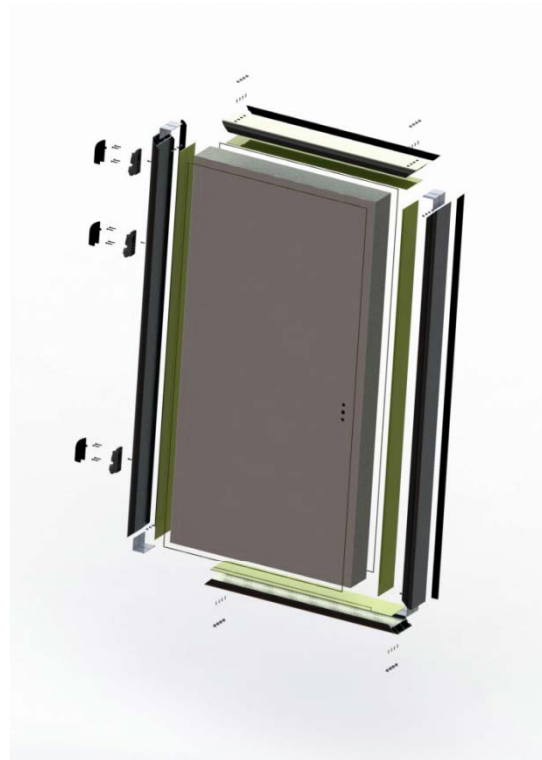
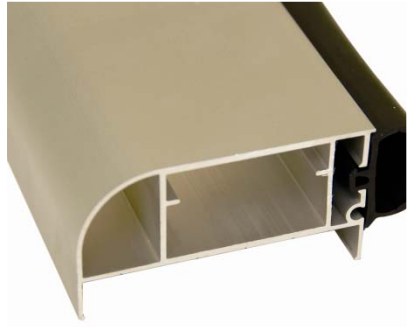



- For Hinged and Sliding Overlapping Doors

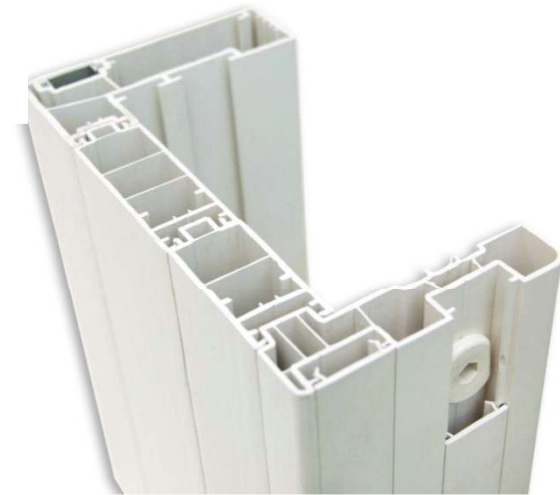
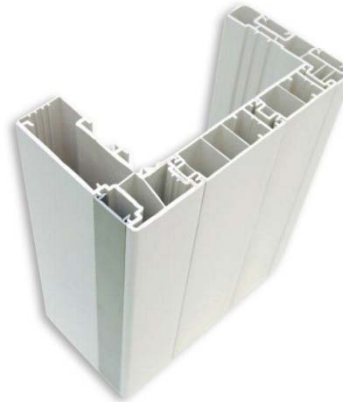
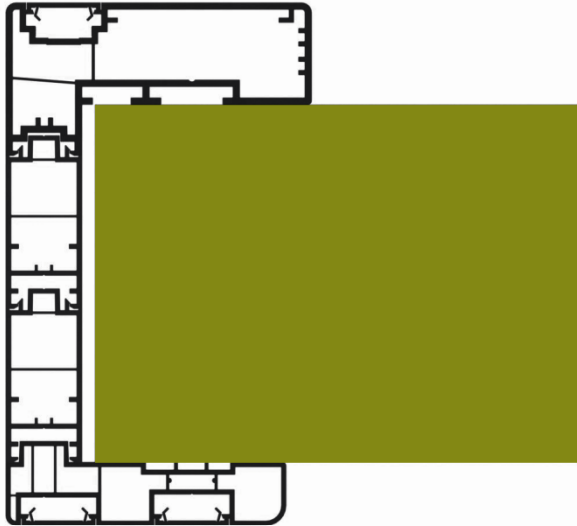

Modular and Extendable
for 60-220 mm
wall thicknesses.



60 - 220 MM
WALL



POSITIVE /
NEGATIVE
TEMP.



- For Office & Coldroom doors



For Office doors

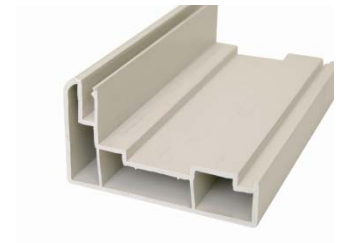

For Cold room doors



• For Sliding Doors

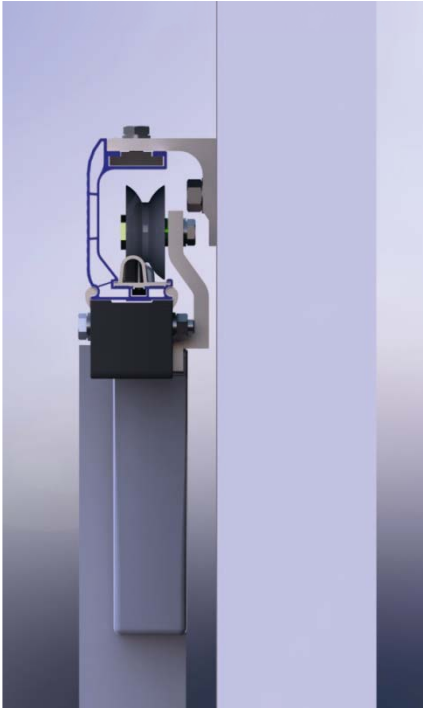



• For Sliding Doors

Serie s 4500.003



Serie s 4500.002



Serie s 4010

Serie s 4500.001

• Panel & Frame Fixations



Thermal break



Reinforced for ceiling suspensions

Camlocks



3-Spacers



Ventilation Tube



Pressure Relief Valve

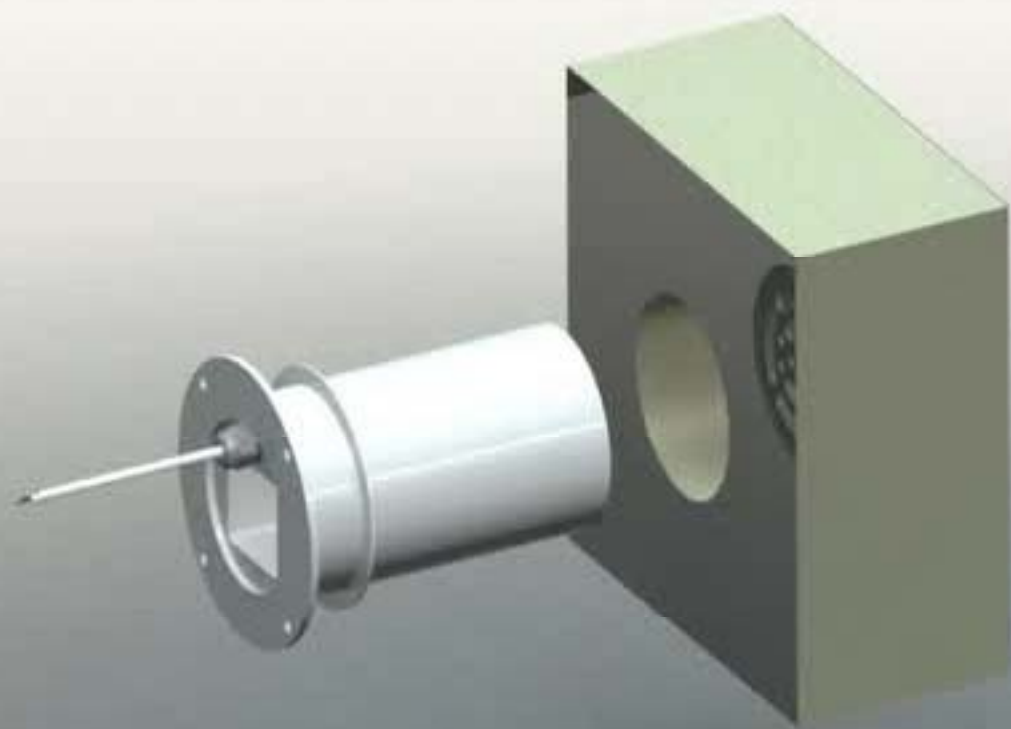

•Accessories for Air Conditioning Installations

Please visit us
in
Hall 7 – 518

