

PRICE LIST

# FİYAT LİSTESİ

PRİES LIST



**GÖKÇELER İÇ VE DIŞ TİC.  
SOĞ. SİS. A.Ş.**



SAYIN / DEAR / HERR : .....

01.08.2006 TARİHİNDEN İTİBAREN GEÇERLİ OLACAK FİYAT LİSTEMİZDİR. İLGİLİ İSKONTO VE ÖDEME ŞEKİLLERİ BİLGİLERİNİZE SUNULMUŞTUR.

THIS PRICE LIST START FROM 01.08.2006

İSKONTO / DISCOUNT	%

- Fiyatlarımıza K.D.V. dahil değildir.
- Fiyatlarımız fabrika teslimidir, nakliye ve sigorta alıcıya aittir.
- Fiyatlarımızı T.C.M.B. döviz satış kuru uygulanmaktadır.

ZERTIFIKAT CERTIFICADO CERTIFICADO CERTIFICADO CERTIFICADO CERTIFICADO CERTIFICADO CERTIFICADO CERTIFICADO CERTIFICADO CERTIFICADO



# ZERTIFIKAT Certificate

Interne Fertigungskontrolle mit Überwachung der Abnahme (Modul A1) nach Richtlinie 97/23/EG  
Internal manufacturing checks with monitoring of the final assessment (Module A1) according to Directive 97/23/EC

Zertifikat-Nr.: DDB-MAN/02/10/100035954-001  
Certificate No.

Name und Anschrift des Herstellers:  
Name and postal address of manufacturer:  
Gökceler Sogutma San.ve Tic.Ltd.Sti.  
Ovaakca Köyü Akşemsettin  
Cad. No: 27  
Bursa - Türkei

Der Hersteller ist nach Prüfung der Voraussetzungen berechtigt, die von ihm im Rahmen des Geltungsbereichs hergestellten Druckgeräte mit unserer Kennnummer gemäß dem abgebildeten CE-Kennzeichen zu kennzeichnen:  
The manufacturer is - after examination of the prerequisites - authorised to provide his pressure equipment manufactured within the scope of the examination with our identification number to the CE-mark as illustrated.

## CE 0036

Prüfbericht Nr.: BB-DDB-MAN/02/09/1234  
Test report No.

Geltungsbereich: Druckbehälter gemäß Bericht TGK 02-3047  
Scope of examination: Betriebsdruck: 24 bar  
Volumen: 9 bis 40 Liter

Fertigungsstätte: Gökceler Sogutma San.ve Tic.Ltd.Sti.  
Manufacturing plant: Ovaakca Köyü Akşemsettin Cad. No: 27  
Bursa - Türkei

Mannheim, 9. Oktober 2002  
(Ort, Datum)  
(Place, date)

Bitte beachten Sie die Hinweise auf der zweiten Seite.  
Please note the remarks on the second page.

TUV Süddeutschland Bau und Betrieb GmbH  
Dampf- und Drucktechnik  
Dudenstraße 28  
D-68167 Mannheim

Tel: (06 21) 3 95-1 15  
Fax: (06 21) 3 95-5 94

TUV Süddeutschland Bau und Betrieb GmbH  
TUV-CERT-Zertifizierungsstelle für Druckgeräte  
*(Dr. Michael Arras)*  
Benannte Stelle, Kennnummer 0036  
Notified Body, No. 0036

Mitglied der CONFÉDÉRATION EUROPÉENNE D'ORGANISMES DE CONTRÔLE  
CEOC  
D'ORGANISMES DE CONTRÔLE

15/02 DGR-Zertifikat Modul A1

Document:



# ZERTIFIKAT Certificate

EG-Baumusterprüfung (Modul B) nach Richtlinie 97/23/EG  
EC Type-examination (Module B) according to Directive 97/23/EC

Zertifikat-Nr.: TR 04/10/ 03-3449 Rev2 PED / 01  
Certificate No.

Name und Anschrift des Herstellers:  
Name and postal address of manufacturer:  
GÖKÇELER İç Ve Dış Tic. Sogutma Sistemleri A.Ş.  
Akşemsettin Cad. No: 27  
Ovaakca / BURSA / TURKEY

Hiermit wird bescheinigt, daß das unten genannte EG-Baumuster die Anforderungen der Richtlinie 97/23/EG erfüllt.  
We herewith certify that the type mentioned below meets the requirements of the Directive 97/23/EC

Prüfbericht Nr.: TGK-BB/ 03-3449 Rev 2 / PED  
Test report No.

Geltungsbereich: Vertikal und Horizontal Liquid  
Scope of examination: Receiverns has capacity 35 lt to 450 lt  
and 13/40 bar PS  
Dwg No:TR 16 01 003/TR16 03 002

Fertigungsstätte: OVAAKÇA / BURSA / TURKEY  
Manufacturing plant:

ISTANBUL, TURKEY, 08. October 2004  
(Ort, Datum)  
(Place, date)

Bitte beachten Sie die Hinweise auf der zweiten Seite.  
Please note the remarks on the second page.

TUV Industrie Service GmbH  
TUV SUD Gruppe  
TUV Süddeutschland TGK  
Yildiz Posta Caddesi / No 17, Kat:5  
TR-34394 Esentepe - Istanbul

Tel: 0090 212 347 98 10  
Fax: 0090 212 347 98 11  
www.tuv.tgk.com

TUV Industrie Service GmbH  
TUV SUD Gruppe  
TUV-CERT-Zertifizierungsstelle für Druckgeräte  
Resonanz 0036  
Stable (FIRKET YASAR)  
Benannte Stelle, Kennnummer 0036  
Notified Body, No. 0036

Mitglied der CONFÉDÉRATION EUROPÉENNE D'ORGANISMES DE CONTRÔLE  
CEOC  
D'ORGANISMES DE CONTRÔLE

04/02/04 DGR-Zertifikat Modul B

GÖKÇELER İç ve Dış Tic. Mod B

DGR-Zertifikat Modul B ist

ZERTIFIKAT CERTIFICADO CERTIFICADO CERTIFICADO CERTIFICADO CERTIFICADO CERTIFICADO CERTIFICADO CERTIFICADO CERTIFICADO CERTIFICADO



# CERTIFICATE

The Certification Body of  
TUV Industrie Service GmbH · TUV SUD Gruppe  
(a Pressure Equipment Directive Notified Body)

certifies that

Gökçeler İç ve Dış Tic.Soğ.Sist.A.Ş.  
Ovaakça Köyü  
Akşemsettin Cd.No:27  
Bursa/TURKEY

has implemented, operates and maintains a quality assurance system as described in the Pressure Equipment Directive (97/23/EC) Annex III, Module D

for the scope of

Production and Sales of Horizontal and Vertical Liquid Receivers between the ranges of PS from 33 bars up to 40 bars and of V from 35 l up to 450 l

Evidence that the quality assurance system satisfies the PED requirements is documented in the Assessment Report No.: TUV-TGK-03-3449

The manufacturer is authorised to provide the pressure equipment manufactured within the scope of the assessed quality assurance system with the below listed Notified Body Identification Number (following the product's CE marking as illustrated):

## CE 0036

Certificate No.: DGR-0036-QS-338-04  
valid until September 22, 2007

Mannheim, September 23, 2004

TUV Industrie Service GmbH  
TUV SUD Gruppe  
Quadenstraße 28  
D-68167 Mannheim

Tel: (0049) 621 38 52 33  
Fax: (0049) 621 39 55 94

*(Signature)*

Notified Body No.: 0036  
Member of CONFÉDÉRATION EUROPÉENNE D'ORGANISMES DE CONTRÔLE  
CEOC  
D'ORGANISMES DE CONTRÔLE

TUV Industrie Service GmbH · TUV SUD Gruppe · PED-QA Certification Body · D-68167 Mannheim



СЕРТИФИКАТ СООТВЕТСТВИЯ

№ РОСС TR.AE11.B 12870

Срок действия с 25.06.04 по 25.06.07  
№ 6080970

ОРГАН ПО СЕРТИФИКАЦИИ

ПРОДУКЦИИ И УСЛУГ НЕКОММЕРЧЕСКАЯ ОРГАНИЗАЦИЯ УЧРЕЖДЕНИЕ  
СЕРТИФИКАЦИИ И ЭКСПЕРТИЗЫ "СЕРТЭК" № РОСС RU.0001.10AE11  
118035, г.Москва, ул.Большая Ордынка, 11/14, для корреспонденции 109147 а/я 80  
Тел.(095) 270-11-24, 270-11-59, Факс (095) 270-86-00, E-mail: mail@serteks.ru

ПРОДУКЦИЯ

Компоненты охлаждающих систем (см. приложение бланк № 1034498).  
Серийное производство по НД изготовителя.

код ОК 005 (ОКП):  
51 5119

СООТВЕТСТВУЕТ ТРЕБОВАНИЯМ НОРМАТИВНЫХ ДОКУМЕНТОВ

ГОСТ 12.2.003-91 п.р. 1, 2;  
ГОСТ 23833-95 п.р. 5, 6.

код ТН ВЭД:  
7311 00 100 0

ИЗГОТОВИТЕЛЬ

"GOKCELER IC VE DIS TICARET SOGUTMA SIS. AS.",  
AKTAR HUSSAM MH. ILGAZLAR CAD. NO: 11 В BURSA, Турция.

СЕРТИФИКАТ ВЫДАН

"GOKCELER IC VE DIS TICARET SOGUTMA SIS. AS.",  
AKTAR HUSSAM MH. ILGAZLAR CAD. NO: 11 В BURSA, Турция,  
тел./факс: 0224 224 44 42/ 0224 222 20 39.

НА ОСНОВАНИИ

Протоколов испытаний № 434-261, № 435-261, № 437-261, № 438-261 от 24.06.2004г.,  
выданных ИА ПМ "РОСТЕСТ-МОСКВА" (РОСС RU.0001.21.MI009).  
Сертификата системы качества ИСО 9001:2000 № HU01/20081 от 06.10.2003г до  
06.10.2006г.

ДОПОЛНИТЕЛЬНАЯ ИНФОРМАЦИЯ

Маркировка знаком соответствия по ГОСТ Р 50460-92 производится на потребительской  
упаковке для и товаросопроводительной документации. Схема сертификации № 3.  
Исследовательский контроль согласно договору №12352/04 от 29.04.2004.

Руководитель органа: Файзуллин Ж.Б.  
Эксперт: Шальдин В.В.

Сертификат имеет юридическую силу на всей территории Российской Федерации



СЕРТИФИКАТ СООТВЕТСТВИЯ

№ РОСС TR.AE11.B 12871

Срок действия с 25.06.04 по 25.06.07  
№ 6080971

ОРГАН ПО СЕРТИФИКАЦИИ

ПРОДУКЦИИ И УСЛУГ НЕКОММЕРЧЕСКАЯ ОРГАНИЗАЦИЯ УЧРЕЖДЕНИЕ  
СЕРТИФИКАЦИИ И ЭКСПЕРТИЗЫ "СЕРТЭК" № РОСС RU.0001.10AE11  
118035, г.Москва, ул.Большая Ордынка, 11/14, для корреспонденции 109147 а/я 80  
Тел.(095) 270-11-24, 270-11-59, Факс (095) 270-86-00, E-mail: mail@serteks.ru

ПРОДУКЦИЯ

Арматура трубопроводная (см. приложение бланк № 1034499).  
Серийное производство по НД изготовителя.

код ОК 005 (ОКП):  
37 1200

СООТВЕТСТВУЕТ ТРЕБОВАНИЯМ НОРМАТИВНЫХ ДОКУМЕНТОВ

ГОСТ 12.2.063-81;  
ГОСТ 21345-78 п.п. 1.18., 1.20., 1.23., 1.25.;  
ГОСТ 12893-83 п.п. 3.5., 3.12., 3.13., 3.16., 3.17., 3.18., 3.25.

код ТН ВЭД:  
8481

ИЗГОТОВИТЕЛЬ

"GOKCELER IC VE DIS TICARET SOGUTMA SIS. AS.",  
AKTAR HUSSAM MH. ILGAZLAR CAD. NO: 11 В BURSA, Турция.

СЕРТИФИКАТ ВЫДАН

"GOKCELER IC VE DIS TICARET SOGUTMA SIS. AS.",  
AKTAR HUSSAM MH. ILGAZLAR CAD. NO: 11 В BURSA, Турция,  
тел./факс: 0224 224 44 42/ 0224 222 20 39.

НА ОСНОВАНИИ

Протоколов испытаний № 436-261, № 439-261 от 24.06.2004г.,  
выданных ИА ПМ "РОСТЕСТ-МОСКВА" (РОСС RU.0001.21.MI009).  
Сертификата системы качества ИСО 9001:2000 № HU01/20081 от 06.10.2003г до  
06.10.2006г.

ДОПОЛНИТЕЛЬНАЯ ИНФОРМАЦИЯ

Маркировка знаком соответствия по ГОСТ Р 50460-92 производится на потребительской  
упаковке для и товаросопроводительной документации. Схема сертификации № 3.  
Исследовательский контроль согласно договору №12352/04 от 29.04.2004.

Руководитель органа: Файзуллин Ж.Б.  
Эксперт: Шальдин В.В.

Сертификат имеет юридическую силу на всей территории Российской Федерации

№1034498

ПРИЛОЖЕНИЕ

К сертификату соответствия № РОСС TR.AE11.B 12870

Перечень конкретной продукции, на которую распространяется  
действие сертификата соответствия

код ОК 005 (ОКП)	Наименование и обозначение продукции, ее изготовитель	Обозначение документации, по которой выпускается продукция
------------------	--	---

51 5119 Компоненты охлаждающих систем:  
7311 00 100 0 - сепараторы мод.: YAG 1601, YAG 1602, YAG 1603, YAG 1604,  
YAG 1605, YAG 1606, YAG 1607, YAG 1608, YAG 8506, YAG 8507,  
YAG 8508, YAG 8509, YAG 8510, YAG 8511, YAG 8512, YAG 8513,  
YAG 8514, YAG 8516;  
- ресиверы мод.: RDSG-30, RDSG-55, RDSG-80, RDSG-100, RDSG-150,  
RDSG-130, RDSG-200, RDSG-250, RDSG-300, RDSG-390, RDSG-560,  
RDSG-730, RDSG-890, RDSG-1120, GMSKR 3012, GMSKR 4015,  
GMSKR 5518, GMSKR 7022, GMSKR 9025, GMSKR 0008, GMSKR 0010,  
GMSKR 0013, GMSKR 0018, GMSKR 0020, GMSKR 0030, GMSKR 0040,  
GMSKR 0050, GMSKR 0060, GMSKR 0070, GMSKR 0100, GMSKR 0130,  
GMSKR 0170;  
- аккумуляторы мод.: LTG 800, LTG 812, LTG 86, LTG 816, LTG 818,  
LTG 1012, LTG 1016, LTG 1018, LTG 1022, LTG 1222, LTG 1228,  
LTG 1522, LTG 1518, LTG 1528, LTG 1535, LTG 1536, LTG 1537,  
LTG 1542, LTG 1543, LTG 2142, LTG 2154, LTG 2155, LTG 2754,  
LTG 2755, LTG 2767, LTG 2768, LTG 2780, LTG 2767, LTG 2782,  
LTG 2790.

Изготовитель: "GOKCELER IC VE DIS TICARET SOGUTMA SIS. AS.",  
AKTAR HUSSAM MH. ILGAZLAR CAD. NO: 11 В BURSA, Турция.



Руководитель органа: Файзуллин Ж.Б.  
Эксперт: Шальдин В.В.

№1034499

ПРИЛОЖЕНИЕ

К сертификату соответствия № РОСС TR.AE11.B 12871

Перечень конкретной продукции, на которую распространяется  
действие сертификата соответствия

код ОК 005 (ОКП)	Наименование и обозначение продукции, ее изготовитель	Обозначение документации, по которой выпускается продукция
------------------	--	---

37 1220 Арматура трубопроводная:  
8481 80 110 0 - краны мод.: VKG006, VKG010, VKG012, VKG016, VKG018, VKG022,  
VKG028, VKG035, VKG042, VKG054, VKG066;  
37 1210 - клапаны мод.: RVG 1"x3/8", RVG 1"x1/2", RVG 1"x5/8", RVG 1"x10",  
8481 80 990 0 RVG 1"x12", RVG 1"x16", RVG 1"x3/4", RVG 1'1/4x3/4", RVG 1'x7/8",  
RVG 1'1/4x7/8", RVG 1'1/4x1'1/8", RVG 1'3/4x1'1/8",  
RVG 1'3/4x1'3/8", RVG 1'3/4x1'5/8";  
37 1200 - соединитель со смотровым окошком мод.: GCG 1-6, GCG 1-10,  
8481 80 190 0 GCG 1-12, GCG 1-16, GCG 2-10, GCG 2-12, GCG 2-16, GCG 2-18, GCG 2-22,  
GCG 3-6, GCG 3-10, GCG 3-12.

Изготовитель: "GOKCELER IC VE DIS TICARET SOGUTMA SIS. AS.",  
AKTAR HUSSAM MH. ILGAZLAR CAD. NO: 11 В BURSA, Турция.



Руководитель органа: Файзуллин Ж.Б.  
Эксперт: Шальдин В.В.

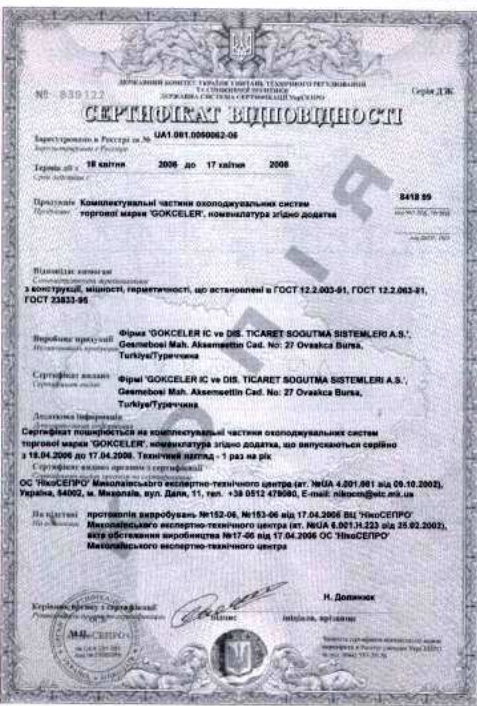
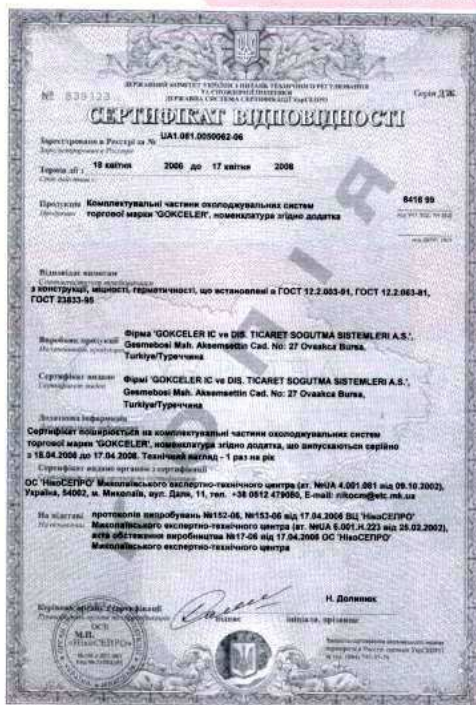
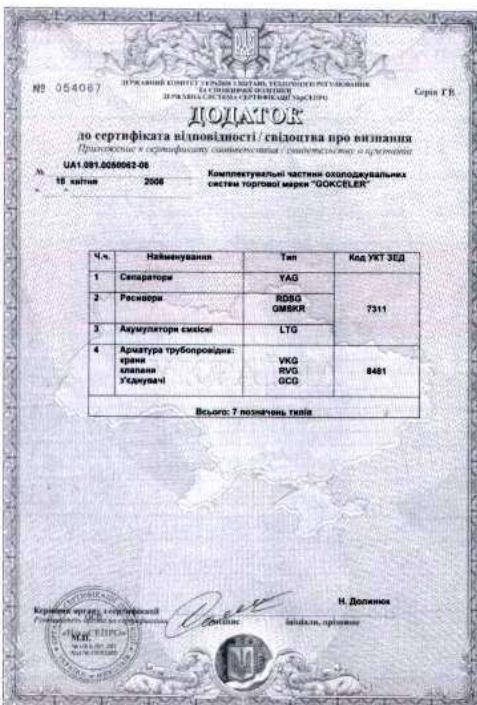
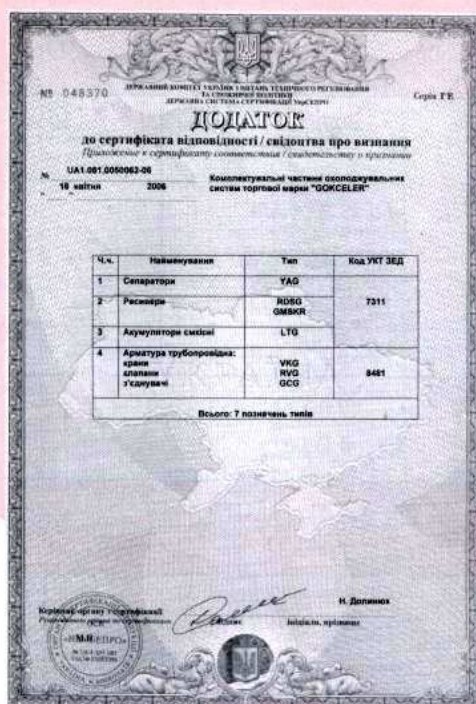

**REKOR  
FLARE NUT - MESSING MUTTERN**

CODE	TYPE	ØC (SAE)		Preis Price
		mm	inch	
01S0020	RFG 22 I 1/4	---	1/4"	0,945 €
01S0040	RFG 24 I 3/8	---	3/8"	1,155 €
01S0060	RFG 28 I 1/2	---	1/2"	1,365 €
01S0080	RFG 36 I 5/8	---	5/8"	2,352 €

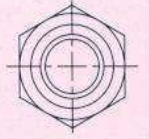
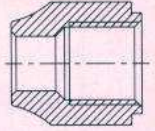

**YAĞ DEPOSU ÇEK VALFİ  
OIL CHECK VALVE - ÖL RÜCKSCHLAGVENTILE**

CODE	TYPE	A UNF	B UNF	Operating Difference Pressure	Preis Price
06S0010	VCYG 01	3/8"	3/8"	0,4 Bar	45,00 €
06S0020	VCYG 04	3/8"	3/8"	0,7 Bar	45,00 €
06S0030	VCYG 15	3/8"	3/8"	1,5 Bar	45,00 €

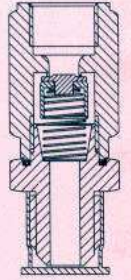

**SERVİS SİBOBU  
CHARGING VALVES - SERVICE VENTILE**

CODE	TYPE	A	B		C	Preis Price
			mm	inch		
03S0010	VSG 010	1/4" (7/16-20 UNF)	6	---	10 mm	1,071 €
03S0020	VSG 035	1/4" (7/16-20 UNF)	6,5	---	10 mm	1,071 €
03S0030	VSG 200	1/4" (7/16-20 UNF)	---	1/8" NPT	---	1,197 €

08 S 0035

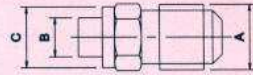

08 S 0010



08 S 0200

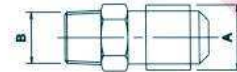

**EMNİYET VALFİ  
SAFETY VALVE - SICHERHEITSVENTILE**

CODE	TYPE	A NPT	B UNF	WORKING PRESSURE	Preis Price
02S0040	VEG 12/24	1/2"	1/2"	24	42,00 €
02S0050	VEG 12/33	1/2"	1/2"	33	42,00 €
02S0060	VEG 12/40	1/2"	1/2"	40	42,00 €

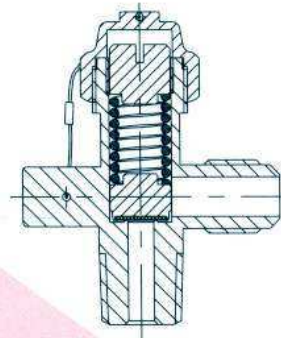

**BASINÇ FİLTRESİ****PRESSURE MECHANICAL FILTER - MECHAN. DRUCK FILTER**

CODE	TYPE	CONNECTIONS		CAT. PS=33	Preis Price
		ØODS (mm)	SAE UNF		
02B0010	FBG 52 - 1/4		1/4"	Cat. 0	12,00 €
02B0020	FBG 52 - 3/8		3/8"		12,00 €
02B0030	FBG 76 - 1/2		1/2"		14,00 €
02B0011	FBG 52 - 6	6			12,00 €
02B0021	FBG 52 - 10	10			12,00 €
02B0031	FBG 76 - 12	12			14,00 €
02B0041	FBG 76 - 16	16			14,00 €
02B0051	FBG 76 - 19	19			18,00 €
02B0061	FBG 76 - 22	22			18,00 €
02B0071	FBG 76 - 28	28			18,00 €

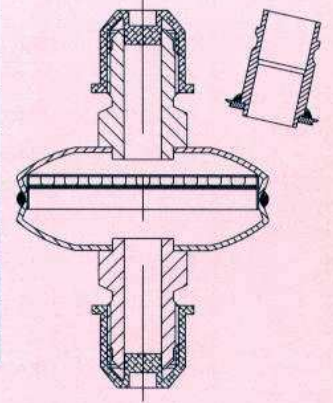
**EMİŞ HAT FİLTRESİ****SUCTION LINE FILTER - SAUGFILTER**

CODE	TYPE	KW	CONNECTIONS		CAT. PS=20	Preis Price
			ØODS (mm)	SAE UNF		
01A0010	FEG 63R	2		3/8"	Cat. 0	15,00 €
01A0011	FEG 63K		10			18,00 €
01A0020	FEG 73R	4		3/8"		23,00 €
01A0021	FEG 73K		10			26,00 €
01A0030	FEG 74R	6		1/2"		29,00 €
01A0031	FEG 74K		12			32,00 €
01A0040	FEG 85R	8		5/8"		38,00 €
01A0041	FEG 85K		16			41,00 €
01A0051	FEG 86K	10	18			44,00 €
01A0061	FEG 87K	14	22			48,00 €
01A0071	FEG 89K	18	28		53,00 €	
01A0081	FEG 811K	25	35		57,00 €	
01A0091	FEG 813K	30	42		60,00 €	

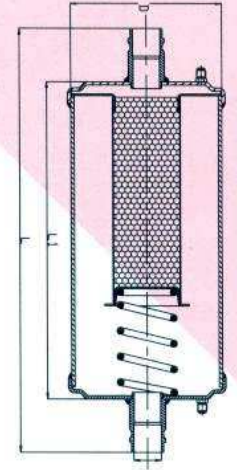
**SUSTURUCU****MUFFLERS - SCHALLDÄMPFER**

CODE	TYPE	KW	ØODS IN -OUT	CAT. PS=33	Preis Price
03B0001	SUG 12	10	12	Cat. 0	30,00 €
03B0011	SUG 16	16	16		33,00 €
03B0021	SUG 18	20	18		42,00 €
03B0031	SUG 22	25	22		37,50 €
03B0041	SUG 28	40	28		45,00 €
03B0051	SUG 35	80	35	Cat. I	52,50 €
03B0061	SUG 42	160	42		60,00 €
03B0071	SUG 54	250	54		75,00 €
03B0081	SUG 66	350	66		90,00 €
03B0091	SUG 89	450	89		97,50 €

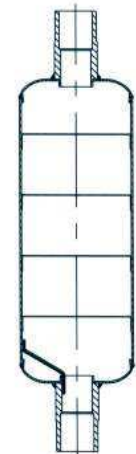

## FILTRE DRAER

## FILTER DRAER MOLECULER - MOLEKULAR FILTER

CODE	TYPE		KW	CONNECTIONS		CAT. PS=33	Preis Price
				A FLARE	ØODS SOLDER		
01B0010	DMG 032		2	1/4"	---	Cat. 0	6,00 €
01B0020	DMG 033		3	3/8"	---		6,00 €
01B0030	DMG 052		4	1/4"	---		6,00 €
01B0040	DMG 053		6	3/8"	---		6,00 €
01B0050	DMG 082		10	1/4"	---		9,00 €
01B0060	DMG 083		12	3/8"	---		10,50 €
01B0070	DMG 084		14	1/2"	---		10,50 €
01B0080	DMG 162		16	1/4"	---		13,50 €
01B0090	DMG 163		18	3/8"	---		13,50 €
01B0100	DMG 164		20	1/2"	---		13,50 €
01B0110	DMG 165		22	5/8"	---		13,50 €
01B0120	DMG 303		26	3/8"	---		21,00 €
01B0130	DMG 304		30	1/2"	---		21,00 €
01B0140	DMG 305		35	5/8"	---		21,00 €
01B0150	DMG 306		35	3/4"	---		21,00 €
01B0160	DMG 414		38	1/2"	---		33,00 €
01B0170	DMG 415		42	5/8"	---		33,00 €
01B0180	DMG 416		42	3/4"	---		33,00 €
01B0011	DMG 032	s	2	---	6		6,00 €
01B0021	DMG 033	s	3	---	10		6,00 €
01B0031	DMG 052	s	4	---	6		6,00 €
01B0041	DMG 053	s	6	---	10		6,00 €
01B0051	DMG 082	s	10	---	6		9,00 €
01B0061	DMG 083	s	12	---	10		10,50 €
01B0071	DMG 084	s	14	---	12		10,50 €
01B0081	DMG 162	s	16	---	6		13,50 €
01B0091	DMG 163	s	18	---	10		13,50 €
01B0101	DMG 164	s	20	---	12		13,50 €
01B0111	DMG 165	s	22	---	16		13,50 €
01B0121	DMG 303	s	26	---	10		21,00 €
01B0131	DMG 304	s	30	---	12		21,00 €
01B0141	DMG 305	s	35	---	16		21,00 €
01B0151	DMG 306	s	35	---	19		21,00 €
01B0161	DMG 414	s	38	---	12	33,00 €	
01B0171	DMG 415	s	42	---	16	33,00 €	
01B0181	DMG 416	s	42	---	19	33,00 €	

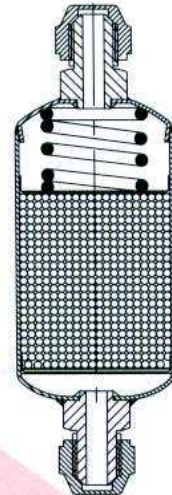

## KARTUŞ FİLTRE FILTER DRAER SHELLS - FILTER GEHÄUSE

CODE	TYPE	IN-OUT ODS	FILTER	CAT. PS=33	Preis Price	
04BK011	FKBG 485	16	1	Cat. I	78 €	
04BK021	FKBG 487	22	1		78 €	
04BK031	FKBG 489	28	1		78 €	
04BK041	FKBG 4811	35	1		78 €	
04BK051	FKBG 4813	42	1		78 €	
04BK061	FKBG 4817	54	1		83 €	
04BK071	FKBG 4821	67	1		83 €	
04BK081	FKBG 4825	80	1		86 €	
04BK121	FKBG 967	22	2		90 €	
04BK131	FKBG 969	28	2		90 €	
04BK141	FKBG 9611	35	2		90 €	
04BK151	FKBG 9613	42	2		90 €	
04BK161	FKBG 9617	54	2		99 €	
04BK171	FKBG 9621	67	2		110 €	
04BK181	FKBG 9625	80	2		120 €	
04BK231	FKBG 14409	28	3		116 €	
04BK241	FKBG 14411	35	3		117 €	
04BK251	FKBG 14413	42	3		119 €	
04BK261	FKBG 14417	54	3		120 €	
04BK271	FKBG 14421	67	3		144 €	
04BK281	FKBG 14425	80	3		180 €	
04BK331	FKBG 19209	28	4		135 €	
04BK341	FKBG 19211	35	4		135 €	
04BK351	FKBG 19213	42	4		138 €	
04BK361	FKBG 19217	54	4		143 €	
04BK371	FKBG 19221	67	4		173 €	
04BK381	FKBG 19225	80	4		210 €	
05BK051	FKBG 20013	42	2		Cat. II	240 €
05BK061	FKBG 20017	54	2			240 €
05BK071	FKBG 20021	67	2			270 €
05BK081	FKBG 20025	80	2			330 €
05BK151	FKBG 30017	54	3			315 €
05BK161	FKBG 30021	67	3	345 €		
05BK171	FKBG 30025	80	3	405 €		
05BK261	FKBG 40017	54	4	390 €		
05BK271	FKBG 40021	67	4	435 €		
05BK281	FKBG 40025	80	4	480 €		
05BK291	FKBG 40027	108	4	555 €		

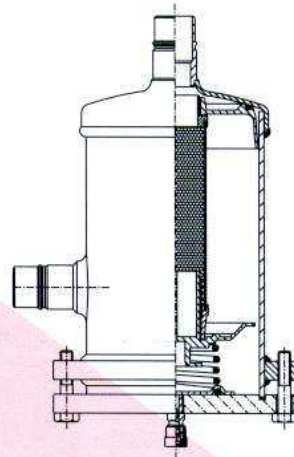

LİKİT DEPOSU SIVAMA  
RECEIVER DEEP DRAW

CODE	CAPACITY	Bağlantılar / Connection		Preis Price
		GİRİŞ / IN	ÇIKIŞ / OUT	
04BS0030	0,75 Lt.	1/4	1/4"-6	18,00 €
04BS0031	0,75 Lt.	6	1/4"-6	18,00 €
04BS0210	1,00 Lt.	1/4	3/4"-6	21,00 €
04BS0211	1,00 Lt.	6	3/4"-6	21,00 €
04BS0230	1,50 Lt.	3/8	3/4"-10	25,50 €
04BS0231	1,50 Lt.	10	3/4"-10	25,50 €
04BS0310	2,00 Lt.	3/8	3/4"-10	27,00 €
04BS0311	2,00 Lt.	10	3/4"-10	27,00 €
04BS0330	3,00 Lt.	3/8	3/4"-10	31,50 €
04BS0331	3,00 Lt.	10	3/4"-10	31,50 €
04BS0401	4,00 Lt.	3/8	3/4"-10	36,00 €
04BS0411	4,00 Lt.	3/8	3/4"-10	36,00 €
04BS0610	6,00 Lt.	1/2-12	1"-12	45,00 €
04BS0811	7,50 Lt.	1/2-12	1"-12	69,00 €
04BS0821	10,00 Lt.	5/8-16	1"-16	72,00 €
04BS1011	15,00 Lt.	5/8-16	1"-16	108,00 €
04BS1021	18,00 Lt.	5/8-16	1"-16	117,00 €
04BS1031	20,00 Lt.	22	1 1/4"-22	120,00 €

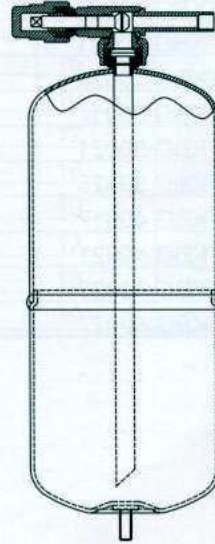
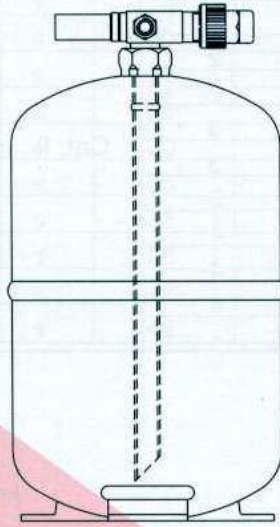

CODE	TYPE	Lt. CAPACITY	CONNECTION IN		OUT VRG	SAFETY VALVE	CAT. PS=33	Preis Price
			inch	mm				
05B0011	RDG 1 A	1,0	1/4"	6	1" 6	--	Cat. 0	33,00 €
05B0021	RDG 1,3 A	1,3	3/8"	10	1" 10	--		34,00 €
05B0031	RDG 1,5 A	1,5	1/4"	6	1" 6	--		34,50 €
05B0041	RDG 2,5 A	2,5	3/8"	10	1" 10	--		36,00 €
05B0051	RDG 3 A	3,0	3/8"	10	1" 10	--		37,50 €
05B0053	RDG 3 B	3,0	3/8"	10	1" 10	--		40,50 €
05B0061	RDG 4 A	4,0	3/8"	10	1" 10	--	Cat. I	42,00 €
05B0063	RDG 4 B	4,0	3/8"	10	1" 10	1/2 NPT		49,50 €
05B0071	RDG 5 A	5,0	3/8"	10	1" 10	--		51,00 €
05B0073	RDG 5 B	5,0	3/8"	10	1" 10	1/2 NPT		54,00 €
05B0081	RDG 6 A	6,0	1/2"	12	1" 12	--		55,50 €
05B0083	RDG 6 B	6,0	1/2"	12	1" 12	1/2 NPT		57,00 €
05B0087	RDG 6 D	6,0	1/2"	12	1" 12	1/2 NPT	60,00 €	
05B0091	RDG 7,5 A	7,5	1/2"	12	1" 12	--	64,50 €	
05B0093	RDG 7,5 B	7,5	1/2"	12	1" 12	1/2 NPT	66,00 €	
05B0097	RDG 7,5 D	7,5	1/2"	12	1" 12	1/2 NPT	72,00 €	
05B0101	RDG 10 A	10,0	5/8"	16	1" 16	--	Cat.II	66,00 €
05B0103	RDG 10 B	10,0	5/8"	16	1" 16	1/2 NPT		67,50 €
05B0105	RDG 10 C	10,0	5/8"	16	1" 16	1/2 NPT		72,00 €
05B0111	RDG 12,5 A	12,5	5/8"	16	1" 16	--		81,00 €
05B0113	RDG 12,5 B	12,5	5/8"	16	1" 16	1/2 NPT		82,50 €
05B0115	RDG 12,5 C	12,5	5/8"	16	1" 16	1/2 NPT		88,50 €
05B0121	RDG 15 A	15,0	5/8"	16	1" 16	--	111,00 €	
05B0123	RDG 15 B	15,0	5/8"	16	1" 16	1/2 NPT	112,50 €	
05B0125	RDG 15 C	15,0	5/8"	16	1" 16	1/2 NPT	117,00 €	
05B0131	RDG 20 A	20,0	5/8"	16	1" 16	--	120,00 €	
05B0133	RDG 20 B	20,0	5/8"	16	1" 16	1/2 NPT	126,00 €	
05B0135	RDG 20 C	20,0	5/8"	16	1" 16	1/2 NPT	129,00 €	
05B0141	RDG 25 A	25,0	3/4"	19	1 1/4" 19	--	Cat.III	139,50 €
05B0143	RDG 25 B	25,0	3/4"	19	1 1/4" 19	1/2 NPT		141,00 €
05B0145	RDG 25 C	25,0	3/4"	19	1 1/4" 19	1/2 NPT		142,50 €
05B0151	RDG 30 A	30,0	3/4"	19	1 1/4" 19	--		157,50 €
05B0153	RDG 30 B	30,0	3/4"	19	1 1/4" 19	1/2 NPT		159,00 €
05B0155	RDG 30 C	30,0	3/4"	19	1 1/4" 19	1/2 NPT		165,00 €
05B0161	RDG 40 A	40,0	7/8"	22	1 1/4" 22	--	187,50 €	
05B0163	RDG 40 B	40,0	7/8"	22	1 1/4" 22	1/2 NPT	189,00 €	
05B0165	RDG 40 C	40,0	7/8"	22	1 1/4" 22	1/2 NPT	195,00 €	

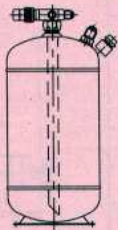

A



B

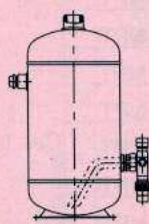

C

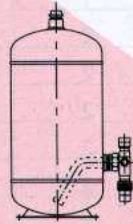

D

**DİK LİKİT DEPOSU GÖZETLEME CAMLI**  
**VERTICAL LIQUID RECEIVERS WITH SIGHT GLASS**  
**STEHENDE SAMMLER MIT SCHAUGLAS**

CODE	TYPE	CAP. Volumen Lt.	Inlet Connection Anschluss Eintritt		Outlet Austritt Rotalog +Flange	CAT. PS=33	CAT. PS=40	Preis Price
			inc	mm				
06B0101	RDCG 35	35	7/8 S K	22	VRG 1 1/4" - 22	Cat. III	Cat. III	270,00 €
06B0111	RDCG 40	40	7/8 S K	22	VRG 1 1/4" - 22			277,50 €
06B0121	RDCG 45	45	7/8 S K	22	VRG 1 1/4" - 22			285,00 €
06B0131	RDCG 60	60	1.1/8 S K	28	VRG 1 1/4" - 28			315,00 €
06B0141	RDCG 80	80	1.1/8 S K	28	VRG 1 1/4" - 28			390,00 €
06B0151	RDCG 90	90	1.1/8 S K	28	VRG 1 1/4" - 28			435,00 €
06B0161	RDCG 100	100	1.3/8 S K	35	VRG 1 3/4" - 35			600,00 €
06B0171	RDCG 125	125	1.3/8 S K	35	VRG 1 3/4" - 35			705,00 €
06B0181	RDCG 150	150	1.5/8 S K	42	VRG 1 3/4" - 42			735,00 €
06B0191	RDCG 175	175	1.5/8 S K	42	VRG 1 3/4" - 42			840,00 €
06B0201	RDCG 200	200	2.1/8 S K	54	VRG 2 1/4" - 54	Cat. IV	---	1.650,00 €
06B0211	RDCG 225	225	2.1/8 S K	54	VRG 2 1/4" - 54			1.710,00 €
06B0221	RDCG 250	250	2.1/8 S K	54	VRG 2 1/4" - 54			1.770,00 €
06B0231	RDCG 300	300	2.1/8 S K	54	VRG 2 1/4" - 54			1.850,00 €
06B0241	RDCG 350	350	FL 100+P	66	FK 100/66			1.950,00 €
06B0251	RDCG 400	400	FL 120+P	66	FK 120/76			2.070,00 €
06B0261	RDCG 450	450	FL 120+P	80	FK 120/80			2.190,00 €

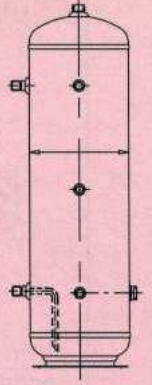

**MERKEZİ SİSTEM DİK LİKİT DEPOSU**  
**CENTRAL SYSTEM LIQUID RECEIVER - CENTRAL SYSTEM - CENTRAL SYSTEME SAMMLER**

CODE	TYPE	CAPACITY Lt.	IN ODS	OUT VRG	H-48 BLOCK FILTER	Safety /Level Connection	CAT. PS=33	CAT. PS=40	Preis Price
12B0021	RDMG 10	10	16	VRG1" 16	1	1/2 NPT	180,00 €		
12B0031	RDMG 13	13	16	VRG1" 16	1	1/2 NPT	195,00 €		
12B0041	RDMG 18	18	18	VRG1 1/4"18	1	1/2 NPT	225,00 €		
12B0051	RDMG 20	20	18	VRG1 1/4"18	1	1/2 NPT	270,00 €		
12B0061	RDMG 30	30	18	VRG1 1/4"18	1	1/2 NPT	315,00 €		
12B0071	RDMG 40	40	22	VRG1 1/4"22	1	1/2 NPT	375,00 €		
12B0081	RDMG 50	50	22	VRG1 1/4"22	1	1/2 NPT	420,00 €		
12B0091	RDMG 60	60	22	VRG1 1/4"22	1	1/2 NPT	495,00 €		
12B0101	RDMG 70	70	28	VRG1 1/4"28	1	1/2 NPT	533,00 €		
12B0111	RDMG 100	100	35	VRG1 3/4"35	1	1/2 NPT	Cat. IV	---	750,00 €
12B0121	RDMG 130	130	35	VRG1 3/4"35	2	1/2 NPT			870,00 €
12B0131	RDMG 170	170	42	VRG2 1/4"42	2	1/2 NPT			990,00 €
12B0141	RDMG 200	200	54	VRG2 1/4"54	2	1/2 NPT			1.750,00 €
12B0151	RDMG 250	250	54	VRG2 1/4"54	2	1/2 NPT			1.870,00 €
12B0161	RDMG 300	300	54	VRG2 1/4"54	2	1/2 NPT			1.950,00 €
12B0171	RDMG 350	350	FL 100	FK 100/66	2	1/2 NPT			2.050,00 €
12B0181	RDMG 400	400	FL 120	FK 120/76	2	1/2 NPT			2.070,00 €
12B0191	RDMG 450	450	FL 120	FK 120/80	2	1/2 NPT			2.290,00 €

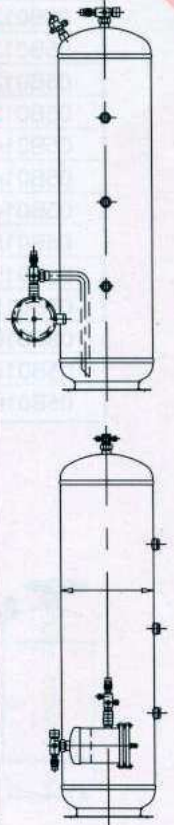

**KOMPAK DEPO**  
**FLÜSSIGKEITSSAMMLER+SAUGSAMMLER(WÄRMETAWSCHER)**  
**LIQUID RECEIVER & SUCTION LINE ACCUMULATOR (HEAT EXCHANGER)**

CODE	TYPE	RECEIVER			SUCTION ACCUMULATOR					Preis Price
		CAPACITY Lt.	CONNECTION		IN-OUT ODS	CAPACITY LT	MAX OIL	Cat ps =33	Cat ps=40	
INLET ØOD	OUTLET ROTALOCK									
10B0001	RDKG 2-1	2,2	S 10	1" - 10	16	1	0,5 Lt.	Cat. I		115,50 €
10B0011	RDKG 3-1	2,7	10	1" - 10	18	1,5	0,5 Lt.			118,50 €
10B0021	RDKG 4-2	4,2	10	1" - 10	22	2	0,5 Lt.			120,00 €
10B0031	RDKG 5-2	4,5	12	1" - 12	22	2,2	0,5 Lt.			129,00 €
10B0041	RDKG 6-3	5	12	1" - 12	28	2,7	0,5 Lt.			142,50 €
10B0051	RDKG 7-3	7	16	1" - 16	28	3,5	1 Lt.	Cat. II		150,00 €
10B0061	RDKG 8-4	8	16	1" - 16	28	4	1 Lt.			157,50 €
10B0071	RDKG 9-4	9	16	1" - 16	35	4,7	1 Lt.			180,00 €
10B0081	RDKG 10-5	10	16	1" - 16	35	5,5	1 Lt.			217,50 €
10B0091	RDKG 11-5	11	18	19	35	5	1 Lt.			240,00 €
10B0101	RDKG 12-6	12	18	19	35	6,5	1 Lt.	Cat. III		255,00 €
10B0111	RDKG 15-7	15	22	22	42	7,5	1 Lt.			285,00 €
10B0121	RDKG 20-9	20	22	22	42	9	1 Lt.			300,00 €
10B0131	RDKG 30-12	30	22	22	54	12	1 Lt.		390,00 €	

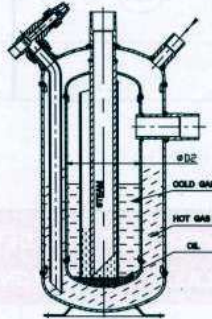

**MERKEZİ SİSTEM KOMPAK DEPO**  
**CENTRAL SYSTEM FLÜSSIGKEITSSAMMLER+SAUGSAMMLER(WÄRMETAWSCHER)**  
**CENTER SYSTEM SUCTION LINE ACCUMULATOR & LIQUID RECEIVER (HEAT EXCHANGER)**

CODE	TYPE	RECEIVER			SUCTION LINE ACCUMULATOR					Pries Price
		CAPACITY Lt.	IN- ODS1	OUT- VRG	IN -OUT ODS	Max Oil	CAT PS=33	CAT PS=40		
11B0011	RDMKG 30-12	30	22	22	42	2	Cat	Cat. III	540,00 €	
11B0021	RDMKG 40-15	40	22	22	42	2			585,00 €	
11B0031	RDMKG 55-18	55	35	35	54	2			690,00 €	
11B0041	RDMKG 70-22	70	35	35	54	2,5			810,00 €	
11B0051	RDMKG 90-25	90	35	35	66	2,5			975,00 €	
11B0061	RDMKG 120-30	120	42	42	66	4	Cat. IV	---	1.260,00 €	
11B0071	RDMKG 150-40	150	42	42	66	4			1.620,00 €	
11B0081	RDMKG 200-50	200	42	42	80	4			1.890,00 €	
11B0091	RDMKG 250-60	250	54	54	80	4			2.160,00 €	
11B0101	RDMKG 300-70	300	54	54	80	4			2.520,00 €	
11B0111	RDMKG 350-80	350	54	54	80	4			2.880,00 €	

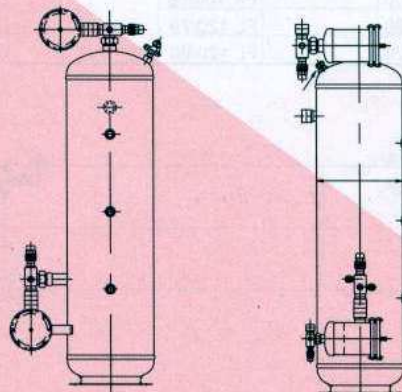

**YATIK LİKİD DEPOSU**  
**HORIZONTAL LIQUID RECEIVERS - HORIZONTALE FLÜSSIGKEITSSAMMLER**

Code /Model	Type	Capacity Volumen Lt.	CONNECTION Anschluss		CAT. PS=33	Pries Price	Sicherheitsv. Safety Valve	Niveau Kont. Level control	Rotalock adapter Inlet /Eintritt
			OUT Austritt	IN Eintritt					
07B0011	RYG 07	07 Lt.	VRG 1" 10	10	Cat. II	57,00 €	30,00 €	90,00 €	12,00 €
07B0021	RYG 10	10	VRG 1" 12	12		66,00 €	30,00 €	90,00 €	12,00 €
07B0031	RYG 15	15	VRG 1" 16	16		90,00 €	30,00 €	90,00 €	12,00 €
07B0041	RYG 20	20	VRG 1 1/4" 22	22		114,00 €	30,00 €	90,00 €	22,50 €
07B0051	RYG 25	25	VRG 1 1/4" 22	22		123,00 €	30,00 €	90,00 €	22,50 €
07B0061	RYG 30	30	VRG 1 1/4" 28	28		141,00 €	30,00 €	90,00 €	22,50 €

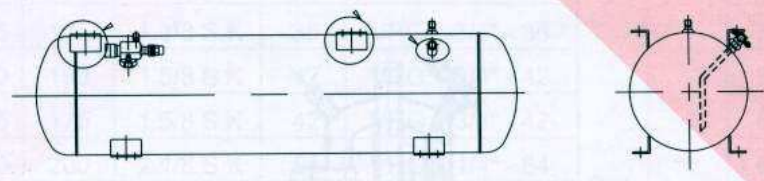

**GÖZETLEMELİ YAKIT LİKİT DEPOSU**  
**HORIZONTAL RECEIVERS WITH SIGHT GLASS - HORIZONTALE SAMMLER MIT SCHAUGLAS**

Code Model	Type	Capacity Volumen Lt.	Inlet		Outlet		CAT. PS=33	CAT PS=40	Pries Price	Safety Valve Sicherheitsv.	Level Control	Rotalock Adapter Inlet	Sight Glass + 1
			ROTALOCK	FLANGE	ROTALOCK	Flange							
08B0101	RYCG 35	35	1 1/4"		1 1/4" - 22		Cat. III	270,00 €	30 €	90 €	26 €	22,5 €	
08B0111	RYCG 40	40	1 1/4"		1 1/4" - 22			277,50 €	30 €	90 €	26 €	22,5 €	
08B0121	RYCG 45	45	1 1/4"		1 1/4" - 22			285,00 €	30 €	90 €	26 €	22,5 €	
08B0131	RYCG 60	60	1 1/4"		1 1/4" - 28			315,00 €	30 €	90 €	26 €	22,5 €	
08B0141	RYCG 80	80	1 1/4"		1 1/4" - 28			390,00 €	30 €	90 €	26 €	22,5 €	
08B0151	RYCG 90	90	1 1/4"		1 1/4" - 28			435,00 €	30 €	90 €	26 €	22,5 €	
08B0161	RYCG 100	100	1 3/4"		1 3/4" - 35			600,00 €	30 €	90 €	82,5 €	22,5 €	
08B0171	RYCG 125	125	1 3/4"		1 3/4" - 35			705,00 €	30 €	90 €	82,5 €	22,5 €	
08B0181	RYCG 150	150	2 1/4"		2 1/4" - 42			735,00 €	30 €	90 €	210 €	22,5 €	
08B0191	RYCG 175	175	2 1/4"		2 1/4" - 42			840,00 €	30 €	90 €	210 €	22,5 €	
08B0201	RYCG 200	200	2 1/4"		2 1/4" - 54	Cat. IV	-	1.650,00 €	30 €	90 €	225 €	37,5 €	
08B0211	RYCG 225	225	2 1/4"		2 1/4" - 54			1.710,00 €	30 €	90 €	225 €	37,5 €	
08B0221	RYCG 250	250	2 1/4"		2 1/4" - 54			1.770,00 €	30 €	90 €	225 €	37,5 €	
08B0231	RYCG 300	300	2 1/4"		2 1/4" - 54			1.850,00 €	30 €	90 €	225 €	37,5 €	
08B0241	RYCG 350	350		FL 100	FK 100/66			1.950,00 €	30 €	90 €	240 €	37,5 €	
08B0251	RYCG 400	400		FL 120	FL 120/76			2.070,00 €	30 €	90 €	240 €	37,5 €	
08B0261	RYCG 450	450		FL 120	FL 120/80	2.190,00 €	30 €	90 €	240 €	37,5 €			

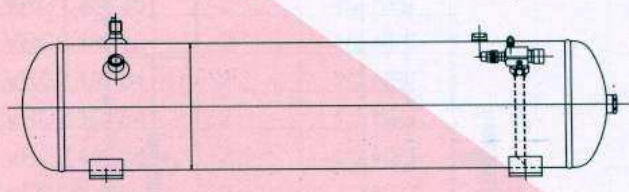

MINIBÜS - OTOBÜS - YAKIT LİKİD DEPOSU  
HORIZONTAL RECEIVERS FOR BUS - HORIZONTALE FÜR BUSSE

CODE	TYPE	CAPACITY Lt.	CONNECTION Anschluss		CAT . PS=33	Pries Price	Safety Valve
			SAE UNF IN LET	RVG OUTLET			
01O0010	RYOG 0,7	0,7	3/8"	1" - 3/8	Cat 0	48,00 €	22,50 €
01O0020	RYOG 1,2	1,2	3/8"	1" - 3/8		49,50 €	22,50 €
01O0030	RYOG 1,5	1,5	1/2"	1" - 1/2		52,50 €	22,50 €
01O0040	RYOG 2,0	2,0	1/2"	1" - 1/2		55,50 €	22,50 €
01O0050	RYOG 2,5	2,5	1/2"	1" - 1/2		57,00 €	22,50 €
01O0060	RYOG 3,0	3,0	5/8"	1" - 5/8	Cat I	58,50 €	22,50 €
01O0070	RYOG 3,5	3,5	5/8"	1" - 5/8		60,00 €	22,50 €
01O0080	RYOG 3,8	3,8	5/8"	1" - 5/8		61,50 €	22,50 €
01O0090	RYOG 4,0	4,0	5/8"	1" - 5/8		63,00 €	22,50 €
01O0100	RYOG 4,5	4,5	5/8"	1" - 5/8		67,50 €	22,50 €

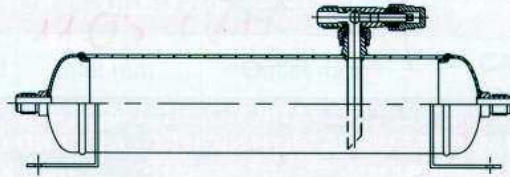

**LİKİD DEPOSU YATIK ve DİK GÖZETLEME CAMLI**  
**HORIZONTAL AND VERTICAL LIQUID RECEIERS WITH SIGHT GLASS**  
**LIEGENDE UND STEHENDE FLÜSSIGKERTS - SAMMLER MIT SCHAUGLAS**

CODE	TYPE	CAP LT	GİRİŞ	İN(ODS)	ÇIKIŞ	OUT(ODS)	Preis Price	GİRİŞ / IN RA
14B0151	RV-HG 015	15	7/8 ODS	22 mm	MR 1 1/4"	+ RV 22	270,00 €	12,00 €
14B0251	RV-HG 025	25	7/8 ODS	22 mm	MR 1 1/4"	+ RV 22	350,00 €	12,00 €
14B0301	RV-HG 030	30	7/8 ODS	22 mm	MR 1 1/4"	+ RV 28	370,00 €	12,00 €
14B0401	RV-HG 040	40	1.1/8 ODS	28 mm	MR 1 1/4"	+ RV 28	380,00 €	15,00 €
14B0601	RV-HG 060	60	1.1/8 ODS	28 mm	MR 1 1/4"	+ RV 28	450,00 €	15,00 €
14B0801	RV-HG 080	80	1.3/8 ODS	35 mm	MR 1 3/4"	+ RV 35	500,00 €	22,50 €
14B1001	RV-HG 100	100	1.3/8 ODS	35 mm	MR 1 3/4"	+ RV 35	700,00 €	22,50 €
14B1201	RV-HG 120	120	1.5/8 ODS	42 mm	MR 1 3/4"	+ RV 35	805,00 €	30,00 €
14B1601	RV-HG 160	160	2.1/8 ODS	54 mm	MR 2 1/4"	+ RV 42	900,00 €	37,50 €
14B2001	RV-HG 200	200	2.1/8 ODS	54 mm	MR 2 1/4"	+ RV 54	1.750,00 €	37,50 €
14B2501	RV-HG 250	250	2.1/8 ODS	54 mm	MR 2 1/4"	+ RV 54	1.870,00 €	37,50 €
14B3001	RV-HG 300	300	2.1/8 ODS	54 mm	MR 2 1/4"	+ RV 54	1.950,00 €	37,50 €

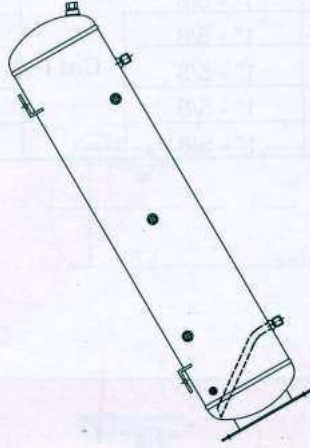

**LİKİD DEPOSU YATIK GÖZETLEME CAMLI VE KOMPRESÖR ŞASELİ**  
**HORIZONTAL RECEIERS WITH SIGHT GLASS AND COMPRESSOR SUPPORT BRACKET**  
**LIEGENDE SAMMLER MIT SCHAUGLAS UND KOMPRESSOR BEFESTIGANG**

CODE	TYPE	CAP LT	GİRİŞ/İN	İN ODS	ÇIKIŞ/OUT	OUT ODS	Preis Price	GİRİŞ / IN RA
15B0071	RYSG 007	07	5/8 ODS	16 mm	MR 1 "	+ RV 12	105,00 €	9,00 €
15B0101	RYSG 010	10	5/8 ODS	16 mm	MR 1 "	+ RV 12	135,00 €	9,00 €
15B0111	RYSG 015	15	7/8 ODS	22 mm	MR 1 "	+ RV 16	195,00 €	12,00 €
15B0201	RYSG 020	20	7/8 ODS	22 mm	MR 1 "	+ RV 16	210,00 €	12,00 €
15B0203	RYSG 020-2	20	7/8 ODS	22 mm	MR 1 1/4"	+ RV 22	232,50 €	12,00 €
15B0251	RYSG 025	25	7/8 ODS	22 mm	MR 1 1/4"	+ RV 22	310,00 €	12,00 €
15B0301	RYSG 030	30	1 1/8 ODS	28 mm	MR 1 1/4"	+ RV 22	340,00 €	15,00 €
15B0401	RYSG 040	40	1.3/4 ODS	35 mm	MR 1 1/4"	+ RV 28	370,00 €	22,50 €
15B0403	RYSG 040-2	40	1.3/4 ODS	35 mm	MR 1 1/4"	+ RV 28	380,00 €	22,50 €
15B0551	RYSG 055	55	1.5/8 ODS	42 mm	MR 1 3/4"	+ RV 35	400,00 €	30,00 €
15B1001	RYSG 0100	100	2.1/8 ODS	54 mm	MR 2 1/4"	+ RV 42	700,00 €	36,00 €

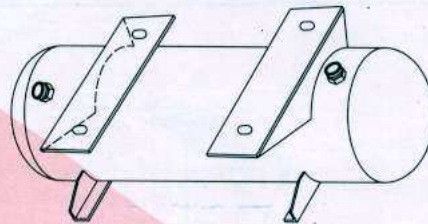
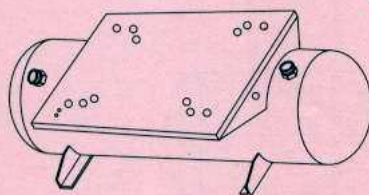

**MERKEZİ SİSTEM KOLLEKTÖR  
MULTI SUCTION LINE ACCUMULATORS - SAUG SAMMLER**

CODE	TYPE	CAPACITY Lt.	INLET 1		OUTLET		CAT. PS=20	Pries Price
			ODS	mm	ODS	mm		
05A0011	KMEG 35-22-2	8		35		2 x 22	Cat. I	180,00 €
05A0021	KMEG 42-22-4	8		42		4 x 22		198,00 €
05A0031	KMEG 54-22-6	8		54		6 x 22		225,00 €
05A0041	KMEG 42-28-4	8		42		4 x 28		255,00 €
05A0051	KMEG 54-28-4	8		54		4 x 28		270,00 €
05A0061	KMEG 66-28-4	20		66		4 x 28	Cat. II	285,00 €
05A0071	KMEG 66-35-4	20		66		4 x 35		300,00 €
05A0081	KMEG 80-42-4	20		80		4 x 42		315,00 €

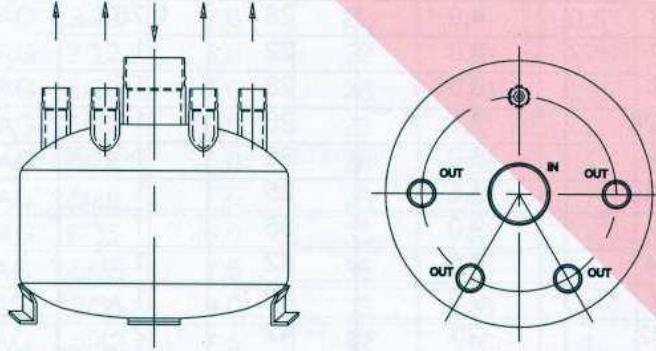

**MERKEZİ SİSTEM KOLLEKTÖR BORU TİPİ  
MULTI SUCTION LINE ACCUMULATORS TUBE TYPE - SAUGSAMMLER ROHR Model**

CODE	TYPE	CAPACITY Lt	Inlet mm	Outlet mm	CAT. PS=20	Pries Price
05A1011	KMEBG 2-42*28-4	18	2 x 42	4 x 28	II	240,00 €
05A1021	KMEBG 2-42*22-4	16	2 x 42	4 x 22	II	210,00 €
05A1031	KMEBG 2-42*22-6	22	2 x 42	6 x 22	II	255,00 €
05A1041	KMEBG 2-54*35-4	22	2 x 54	4 x 35	II	270,00 €
05A1051	KMEBG 2-54*28-4	22	2 x 54	4 x 28	II	285,00 €
05A1061	KMEBG 2-54*28-6	22	2 x 54	6 x 28	II	300,00 €
05A1071	KMEBG 2-54*42-3	30	2 x 54	3 x 42	II	330,00 €
05A1081	KMEBG 2-66*42-4	30	1 x 66	4 x 42	II	360,00 €

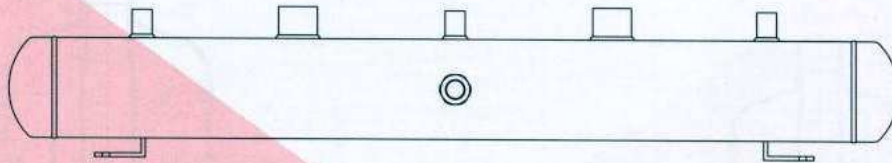

**LİKİD TUTUCU**  
**SUCTION LINE ACCUMULATOR - SAUGSAMMLER**

CODE	TYP	CAPACITY Lt.	IN-OUTODS	Max OIL Lt.	CAT. PS=20	Preis Price
02A0021	LTG 1/12	1,0	12	0,5	Cat. 0	30,00 €
02A0031	LTG 1.5/12	1,5	12	0,5		32,00 €
02A0041	LTG 1/16	1,0	16	0,5		30,00 €
02A0051	LTG 1.5/16	1,5	16	0,5		32,00 €
02A0061	LTG 1.5/18	1,5	18	0,5		32,00 €
02A0071	LTG 2/12	2,0	12	0,5		53,00 €
02A0081	LTG 2/16	2,0	16	0,5		39,00 €
02A0091	LTG 2/18	2,0	18	0,5		42,00 €
02A0101	LTG 2/22	2,0	22	0,5		44,00 €
02A0111	LTG 3/22	3,0	22	0,75		48,00 €
02A0121	LTG 4/28	4,0	28	0,75	53,00 €	
02A0131	LTG 6/22	6,0	22	1	Cat. I	60,00 €
02A0141	LTG 6/28	6,0	28	1		63,00 €
02A0151	LTG 7.5/28	7,5	28	1		69,00 €
02A0161	LTG 6/35	6,0	35	1		72,00 €
02A0171	LTG 7.5/35	7,5	35	1		83,00 €
02A0181	LTG 9/35	9,0	35	1		90,00 €
02A0191	LTG 7.5/42	7,5	42	1		98,00 €
02A0201	LTG 9/42	9,0	42	1		99,00 €
02A0211	LTG 20/42	20	42	2		128,00 €
02A0221	LTG 15/54	15	54	2		135,00 €
02A0231	LTG 20/54	20	54	2	Cat. II	149,00 €
02A0241	LTG 35/54	35	54	2,5		198,00 €
02A0251	LTG 50/54	50	54	2,5		248,00 €
02A0261	LTG 35/66	35	66	2,5		293,00 €
02A0271	LTG 50/66	50	66	2,5		323,00 €
02A0281	LTG 70/80	70	80	4		363,00 €
02A0291	LTG 70/90	70	90	4	Cat. III	420,00 €
02A0301	LTG 80/90	80	90	8		1.275,00 €
02A0311	LTG 100/90	100	90	8		1.350,00 €
02A0321	LTG 125/90	125	90	8		1.425,00 €
02A0331	LTG 150/108	150	108	8		1.500,00 €
02A0341	LTG 175/108	175	108	8	Cat. IV	1.650,00 €
02A0351	LTG 200/139	200	139	8		1.800,00 €
02A0361	LTG 250/139	250	139	8		1.950,00 €

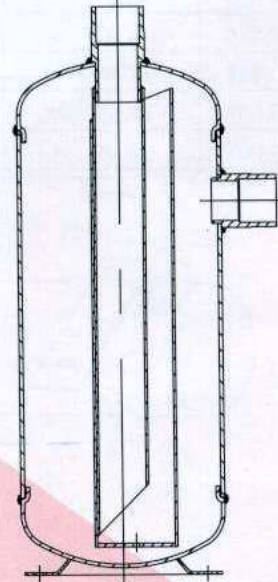

**LİKİD AKÜMÜLATÖRÜ**  
**SUCTION ACCUMULATOR (HEAT EXCHANGER) - SAUG ACCUMULATOR**  
**(WÄRMETAUSCHER)**

CODE	TYPE	CAP. Lt.	IN-OUT ODS1	IN-OUT ODS2	Max OIL Lt.	CAT. PS=20	Preis Price
03A0011	LTAG 1/12	1,0	12	6	0,5	Cat. 0	45,00 €
03A0021	LTAG 1.5/12	1,5	12	6	0,5		48,00 €
03A0031	LTAG 1/16	1,0	16	6	0,5		53,00 €
03A0041	LTAG 1.5/16	1,5	16	6	0,5		60,00 €
03A0051	LTAG 1.5/18	1,5	18	6	0,5		68,00 €
03A0061	LTAG 2/12	2,0	12	8	0,5		80,00 €
03A0071	LTAG 2/16	2,0	16	8	0,5		83,00 €
03A0081	LTAG 2/18	2,0	18	8	0,5		90,00 €
03A0091	LTAG 2/22	2,0	22	8	0,5		98,00 €
03A0101	LTAG 3/22	3,0	22	10	0,75	Cat. I	105,00 €
03A0111	LTAG 4/28	4,0	28	10	0,75		110,00 €
03A0121	LTAG 6/22	6,0	22	12	1		113,00 €
03A0131	LTAG 6/28	6,0	28	12	1		114,00 €
03A0141	LTAG 7.5/28	7,5	28	16	1		128,00 €
03A0151	LTAG 6/35	6,0	35	12	1		132,00 €
03A0161	LTAG 7.5/35	7,5	35	16	1		135,00 €
03A0171	LTAG 9/35	9,0	35	16	1		143,00 €
03A0181	LTAG 7.5/42	7,5	42	16	1		150,00 €
03A0191	LTAG 9/42	9,0	42	16	1		165,00 €
03A0201	LTAG 20/42	20	42	22	2	Cat. II	180,00 €
03A0211	LTAG 15/54	15	54	22	2		195,00 €
03A0221	LTAG 20/54	20	54	22	2		218,00 €
03A0231	LTAG 35/54	35	54	28	2,5		315,00 €
03A0241	LTAG 50/54	50	54	35	2,5		375,00 €
03A0251	LTAG 35/66	35	66	28	2,5		390,00 €
03A0261	LTAG 50/66	50	66	35	2,5		420,00 €
03A0271	LTAG 70/80	70	80	35	4		480,00 €
03A0281	LTAG 70/90	70	90	35	4	525,00 €	
03A0291	LTAG 80/90	80	90	35	8	Cat. III	1.575,00 €
03A0301	LTAG 100/90	100	90	35	8		1.650,00 €
03A0311	LTAG 125/90	125	90	35	8		1.725,00 €
03A0321	LTAG 150/108	150	108	35	8		1.875,00 €
03A0331	LTAG 175/108	175	108	42	8	Cat. IV	2.025,00 €
03A0341	LTAG 200/139	200	139	42	8		2.100,00 €
03A0351	LTAG 250/139	250	139	42	8		2.250,00 €

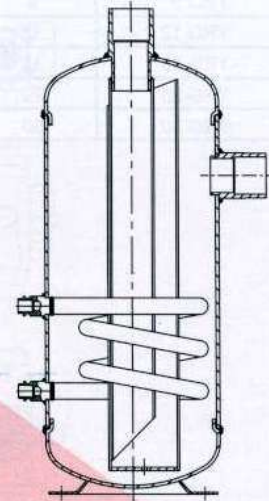

**YAĞ SEVİYE REGÜLATÖRÜ MEKANİK  
OIL REGULATORS ÖLREGULATOREN**

CODE	TYPE	OIL ADJUSTMENT		FLANGE	SIGHT GLASS	WORKING		OIL INLET	CAT ps=33	Preis Price
		min.	max.			min.	max.			
02Y0010	YSRG FL 0	Fixed at center		FL 3*6mm	0*	1,5 Bar	4,5 Bar	3/8"	Cat 0	135,00 €
02Y0020	YSRG FL 2	Fixed at center		FL 3*6mm	2*	1,5 Bar	4,5 Bar	3/8"		143,00 €
02Y0030	YSRG FLE 2 A	- 5mm	+4mm	FL 3*6mm	2*	1,5 Bar	6,5 Bar	3/8"		150,00 €
02Y0040	YSRG FLE 2 B	- 5mm	+4mm	FL 4*6mm	2*	1,5 Bar	6,5 Bar	3/8"		150,00 €
02Y0050	YSRG FL-FL	Fixed at center		FL 3*6mm	0*	1,5 Bar	4,5 Bar	3/8"		143,00 €
02Y2000	YSRG FL 4	NEW MODEL		NEW	1	1,5 Bar	4,5 Bar	3/8"		

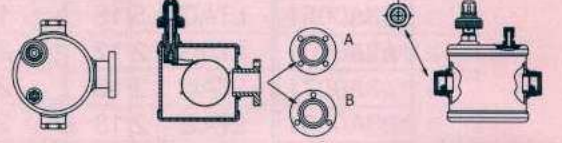

**YAĞ SEVİYE REGÜLATÖRÜ ADAPTÖRÜ  
OIL REGULATOR ADAPTER ÖLREGULATOREN ADAPTER**

CODE	TYPE	CONNECTION	FL / FL	FL / BOLT	CAT. PS20	Preis Price
03Y0010	MODEL A	FL 3 BOLT		FLARE 1 1/8-12	Cat 0	45,00 €
03Y0020	MODEL BI	FL 3 BOLT	FL 4x 6.8 mm			45,00 €
03Y0030	MODEL BO	FL 3 BOLT	FL 4x 6.8 mm			48,00 €
03Y0040	MODEL MA	FL 3 BOLT		FLARE 1 1/8-18		45,00 €
03Y0050	MODEL R	FL 3 BOLT	FL 3x 6.8 mm			48,00 €
03Y0060	MODEL TK	FL 3 BOLT		FLARE 3/4 NPT		45,00 €
03Y0070	MODEL MT	FL 3 BOLT		FLARE R 1-1/2		45,00 €
03Y0080	MODEL CR	FL 3 BOLT		FLARE 1 1/2-18		51,00 €

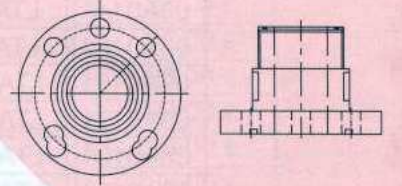

**YAĞ DEPOSU  
OIL RECEIVERS ÖL BEHÄLTER**

CODE	TYPE	CAPACITY Lt.	CAT. PS=20	OIL IN-OUT	PRESION CONNECT	Preis Price
01Y0010	YRG 4	4	Cat I	VRG 1" 3/8	SAE 3/8	83,00 €
01Y0020	YRG 7	7		VRG 1" 3/8	SAE 3/8	98,00 €
01Y0030	YRG 9	9		VRG 1" 3/8	SAE 3/8	113,00 €
01Y0040	YRG 12	12		VRG 1" 3/8	SAE 3/8	135,00 €
01Y0050	YRG 15	15	Cat II	VRG 1" 3/8	SAE 3/8	150,00 €
01Y0060	YRG 20	20		VRG 1" 3/8	SAE 3/8	158,00 €
01Y0070	YRG 30	30		VRG 1" 3/8	SAE 3/8	180,00 €

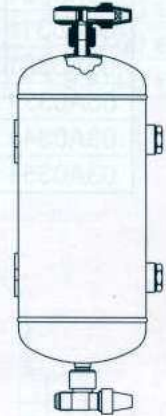

## YAĞ FİLTRESİ OIL FILTER ÖL FILTER

CODE	TYPE	CONNECTIONS IN -OUT		CAT. PS=20	Preis Price
		ØODS	SAE UNF		
06Y0011	FYG 52 S	6		Cat. 0	12,00 €
06Y0010	FYG 52		1/4"		11,00 €
06Y0021	FYG 53 S	10			12,00 €
06Y0020	FYG 53		3/8"		11,00 €
06Y0031	FYG 83 S	10			15,00 €
06Y0030	FYG 83		3/8"		14,00 €
06Y0041	FYG 84 S	12			15,00 €
06Y0040	FYG 84		1/2"		14,00 €

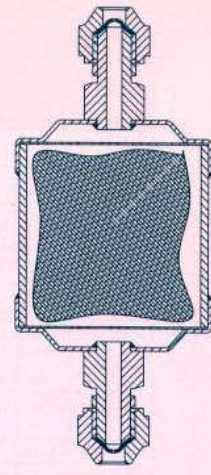

## YAĞ VE LİKİD SEVİYE KONTROL OPTİK SENSÖR ELECTRONIC LEVEL CONTROL OIL / LIQUID - NIVEAU KONTROLLE ÖL / FLÜSSIGKEIT

CODE	TYPE	MODEL	SIGHT GLASS	CONNECTION	GİRİŞ / IN CONNECTION	WORKING PRESURE	Preis Price
02Y5000	OSC 1	LEVEL KONTROL LIQUID	AA 24	1/4 SAE	1 1/4	40 Bar	115,00 €
02Y6000	OSC 2	OIL REGULATOR + KOMPRESOR START	AA 24	1/4 SAE	1 1/4	41 Bar	150,00 €

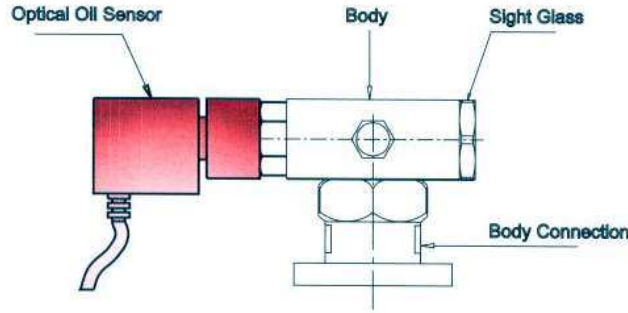

## YAĞ VE LİKİD SEVİYE KONTROL OPTİK SENSÖR ADAPTER ADAPTOR FOR LEVEL CONTROL - ADAPTOR FÜR NIVEAU KONTROLLE

CODE	TYPE	MODEL	CONNECTION	CONNECTION	CONNECTION	WORKING PRESURE	Preis Price
05Y7010	ADP 1	ADAPTER GÖZETLEME 1 1/4"- 3 & 4 delik	1 1/4"	3x6,5mm	4x6,5mm	40 Bar	23,00 €
05Y7020	ADP 2	ADAPTER GÖZETLEME 1 1/4" -1 1/8"	1 1/4"	1 1/8"		40 Bar	12,00 €

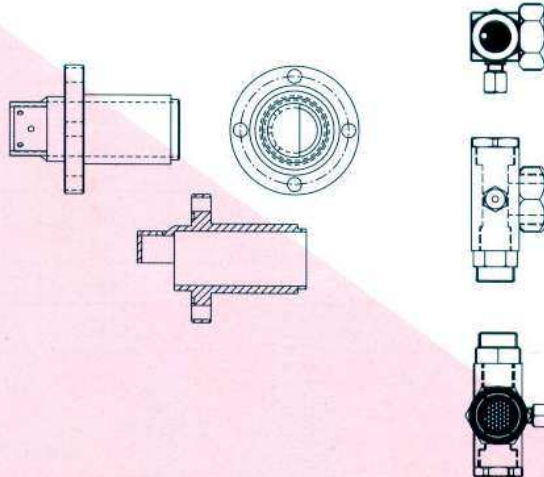

**YAĞ AYIRICI**  
**OIL SEPERATOR - ÖL ABSCHIEDER**

CODE	TYPE	MAX OIL Lt.	CONNEX IN-OUT		CAT. PS=33	CAT. PS=40	Preis Price
			ØODS	FLANGE			
05Y1011	YAG 1 - 12	0,4	12		Cat.0	Cat. I	54,00 €
05Y1021	YAG 1 - 16	0,4	16				54,00 €
05Y1031	YAG 1 - 18	0,4	18				57,00 €
05Y1041	YAG 1 - 22	0,4	22				60,00 €
05Y1051	YAG 1 - 28	0,6	28		Cat. I	Cat. I	66,00 €
05Y1061	YAG 1 - 35	0,6	35				75,00 €
05Y1071	YAG 1 - 42	0,6	42				132,00 €
05Y1081	YAG 1 - 54	0,6	54				148,50 €
05Y2061	YAG 2 - 35	1	35		Cat. II	Cat. II	187,50 €
05Y2071	YAG 2 - 42	1	42				225,00 €
05Y2081	YAG 2 - 54	1	54	FI 90			240,00 €
05Y2091	YAG 2 - 66	1	66	FI 100			300,00 €
05Y2101	YAG 2 - 80	1	80	FI 120	Cat. II	Cat. II	330,00 €
05Y3081	YAG 3 - 54	1	FL 90	FL 90			675,00 €
05Y3091	YAG 3 - 66	1	FL 100	FL 100			750,00 €
05Y3101	YAG 3 - 80	1	FL 120	FL 120			900,00 €
05Y3111	YAG 3 - 90	1	FL 120	FL 120	Cat. III	Cat. III	1.230,00 €
05Y3121	YAG 3 - 108	1	FL 120	FL 120	Cat. IV		1.275,00 €
05Y4081	YAG 4 - 54	2	FL 90	FL 90	Cat. III	Cat. III	1.575,00 €
05Y4091	YAG 4 - 66	2	FL 100	FL 100			2.325,00 €
05Y4101	YAG 4 - 80	2	FL 120	FL 120			3.450,00 €
05Y4111	YAG 4 - 90	2	FL 120	FL 120			8.250,00 €
05Y4121	YAG 4 - 108	2	FL 120	FL 120	Cat. IV	-----	8.400,00 €

MODEL 3

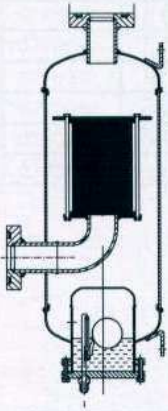

MODEL 4

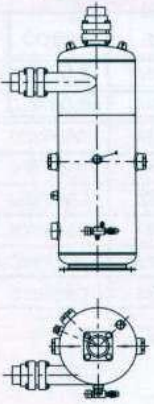

MODEL 1

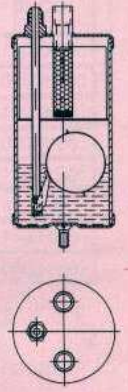

MODEL 2

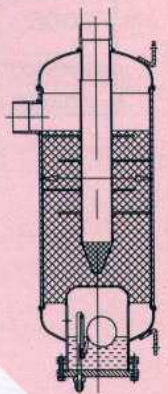

**YAĞ AYIRICILI YAĞ DEPOSU**  
**OIL SEPERATOR AND OIL RECEVIER - KOMBI ÖLABSCHEIDER-ÖLSAMMLER**

CODE	TYPE		YAG OIL LT	YAG/ OIL ÇIKIŞ / INLET	GİRİŞ/ IN ODS	ÇIKIŞ/OUT ODS	WORKING PRESURE	Preis Price
12Y0011	YADG	416	4	1' 3/8	16	16	33 Bar	80,00 €
12Y0021	YADG	422	4	1' 3/8	22	22		95,00 €
12Y0031	YADG	428	4	1' 3/8	28	28		99,00 €
12Y1021	YADG	722	7	1' 3/8	22	22		112,00 €
12Y1031	YADG	728	7	1' 3/8	28	28		125,00 €
12Y2031	YADG	1228	12	1' 3/8	28	28		145,00 €
12Y2041	YADG	1235	12	1' 3/8	35	35		150,00 €
12Y3041	YADG	2035	20	1' 3/8	35	35		170,00 €
12Y3051	YADG	2042	20	1' 3/8	42	42		180,00 €
12Y3061	YADG	2054	20	1' 3/8	54	54		190,00 €
12Y4051	YADG	3042	30	1' 3/8	42	42		220,00 €
12Y4061	YADG	3054	30	1' 3/8	54	54		240,00 €
12Y4071	YADG	3066	30	1' 3/8	66	66		260,00 €
12Y5061	YADG	5054	50	1' 5/8	54	54		300,00 €
12Y5071	YADG	5066	50	1' 5/8	66	66		340,00 €

www.gokcelersogutma.com

**Import And Export  
Company**

**RC** | **REFRIComP**  
refrigeration components

DIS. TIC.

**SEZGIN GOKCE**

- Address:  
Cesmebasi Mh. Aksemsettin Cd. No:27  
Ovaakca / BURSA / TURKEY
- Phone : +90 224 267 11 91 Fax: +90 224 267 11 90
- e-mail : info@refricomp.eu
- web : www.refricomp.eu



**GÖKÇELER İÇ VE DIŞ TIC.  
SOĞ. SİS. A.Ş.**

Fabrika : Çesmebasi Mh.

Aksemsettin Cd No.27

Ovaakca / Bursa

Tel: (+ 90) 224 - 267 11 91 - 94

Fax: (+ 90) 224 - 267 11 90