



AERIAL®

Instruction manual

Dehumidifier

AD 740 / 750 / 770 / 790



valid: 02-2008

Index

1	General advice	3
2	Mode of functioning	3 - 4
3	Safety	4
4	Installation and transport	5
5	Operation	
5.1	Electrical connection	5
5.2	Putting into operation	6
5.3	Operation panel AD 740 / 750	6
5.4	Operation panel AD 770 / 790	7
5.5	Description of operation panel	7
5.6	Hygrostat control	7 - 8
5.7	Condensate outlet AD 740 / 750	9
5.8	Condensate outlet AD 770 / 790	9
5.9	Condensate pump (option)	9
5.10	Automatic defrosting	9
6	Operating conditions	10
7	Technical data	10 - 11
8	Service and maintenance	11 - 12
9	Trouble shooting	12 - 13
10	Disposal	13
11	Circuit diagram	14
12	Manufacturer's declaration	15

1. General advice

You have bought an air dryer made by AERIAL thus deciding for a proven quality product "Made in Germany". If there are any questions, you will find some advice in this manual how to eliminate such difficulties as quickly as possible.

ATTENTION:

Immediately after receipt, you should check your air dryer for transport damage! In the case of damage, you should inform the forwarding agent, parcel service, post office etc. accordingly upon receipt, and make a note of it on the forwarding documents!

If a transport damage should be noticed after unpacking the equipment, please contact immediately your respective seller or specialized dealer.

Before putting your air dryer into operation for the very first time, these instructions for operation should be studied very thoroughly. Thus, you can make sure that this appliance will operate perfectly for a long period of time saving yourselves unnecessary repairs and expenses.

In the case of malfunction disconnect your appliance and ensure that it is not connected again by taking the mains plug out of the socket.

Please, keep the device wrapping in order to be able to send the device safe for guarantee repair. In order to save space you open simply the adhesive tape with a knife and you fold the carton.

2. Mode of functioning

The AD-air dryer is constructed exclusively for air drying in closed rooms. That dehumidifier can prevent the formation of condensation, eliminate too high air humidity and hold a specific air humidity constant. The time which the dryer requires in order to achieve a specific humidity depends essentially on the environmental conditions. The attainable humidity value is equally dependent on the environmental conditions.

The AD-dehumidifier works according to the condensation principle with heat recovery. The fan (shown indicatively below) suck the moist air through a cool register (evaporator). The air becomes so far chilled under the point of condensation here, that the moist air condense as water and flows into the water-collecting tank. The chilled and dried air is warmed up at the condenser again. Through the heat pump effect, the outlet air is some degrees warmer than the sucked room air. Useful energy can conducted up to 3-fold of the electrical power consumption. The absolute moisture of air is lowered continuously by the continuous circulation of the room air through the device. The surplus moisture is removed safely and efficiently.

- 1 – wet room air
- 2 – dry air
- 3 – evaporator
- 4 – condenser
- 5 – water tank
- 6 – compressor
- 7 – fan

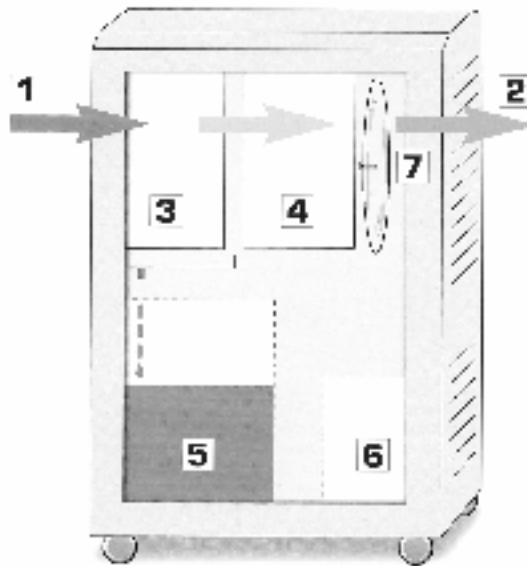

3. Safety

The condensation dryers AD 7 are furnished with protective devices. The devices were subjected to a safety examination. Dangers threaten in the case of operating error or abuse

- for the user.
- for the machine and other real values.
- for the efficient work of the machine.

All persons who have to do with the installation, service and maintenance of the devices must be qualified correspondingly and consider this operating manual precisely.

Using as directed

The condensation dryers are intended for the drying of air with atmospheric pressure.

Risk by accessory

Hoses for condensate removal and air filters must be fit expertly and must not take the protective devices of the condensation dryers out of operation. The control elements must always remain freely amenable.

Authorized users

The service of the condensation dryers AD 7 may only be carried out by persons, who were instructed from the operator. The user is responsible in the field of action third parties compared to.

Responsibilities for different activities on the device must of course be determined and kept. Unclear competences are a safety hazard.

The operator must make the operating instruction available for the user and make sure that the user did understand the manual.

4. Installation and transport

The AD 7.. is planned for the mobile effort. During the setting up and transportation of the dehumidifier, the following items are to be considered:

- That dehumidifier must be installed so that the air can circulate without obstruction through him. The air filter and also the outlet grille of the front wall must not be covered. The open space before the outlet grille and the air filter must at least conduct 1 meter.
- Before every local alternation of the device, switch off the device at the on/off-switch, pull the power plug from the socket and empty the water tank!
- The air dryer must be moved only using the provided wheels and handhold!
- The air dryer must be installed on a plane base only, as otherwise it must be secured against rolling off!
- That dehumidifier can be transported upright or laid flat! The upright transportation is to be preferred if possible.
- The appliance must be used exclusively for air drying.

ATTENTION:

Do never pull or move the device at the power cable

5. Operation

5.1 electrical connection

Before connecting the air dryer, the following items must be checked:

- Does the mains voltage coincide with the voltage of the appliance?
- Adequate fusing of socket and supply system?
- Has the required residual-current-operated circuitbreaker (r.c.c.b) been installed in case of swimming baths?
- If a cable drum is used: has it been unwound completely?
- Is the appliance connector suitable for the building socket?
- Is the socket provided with a earth connection?

ATTENTION:

Before putting the air dryer into operation, the technical data of the appliance should be compared to the conditions prevailing in the room of installation!

5.2 Putting into operation

ATTENTION:

Before putting the air dryer into operation, the instruction manual should be studied carefully. Thus, damages by a false or inappropriate operation as well as by inadequate environmental conditions can be avoided.

For using the air dryer, please proceed as follows:

- After having been transported, the air dryer should rest for about 15 min. During this period of time, the oil inside the refrigerating system, that was foamed during transport will return into the compressor. We recommend this procedure since it extends the service life of the compressor.
- Put the plug into the socket.
- Check whether the bucket is placed in the unit (AD 730 / 740 standard) or a drain hose has been fastened and laid appropriately (AD 770 / 790 standard, AD 730 / 750 option).
- Switch on the unit by actuating the ON-OFF-switch.
- Set the required humidity value at the hygostat (please refer in this respect to 'Hygostat Control').
- If the existing humidity is higher than the set value, the air dryer will start to operate.
If the existing humidity is lower than the set value, the air dryer will not start to operate

5.3 Operation panel AD 740 / AD 750

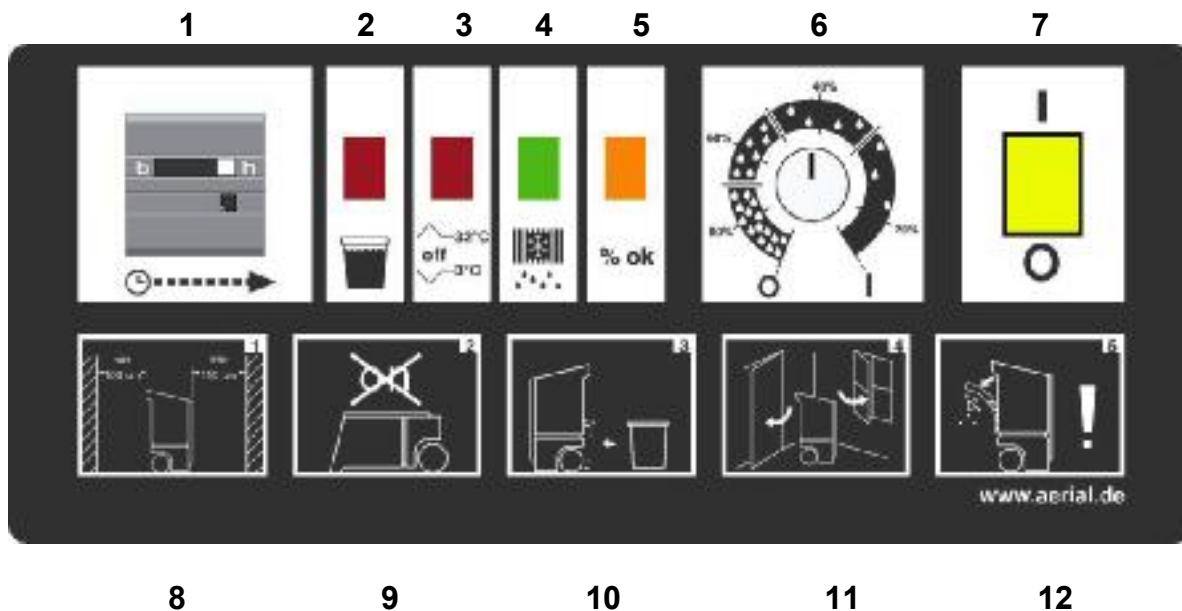

5.4 Operation panel AD 770 / AD 790

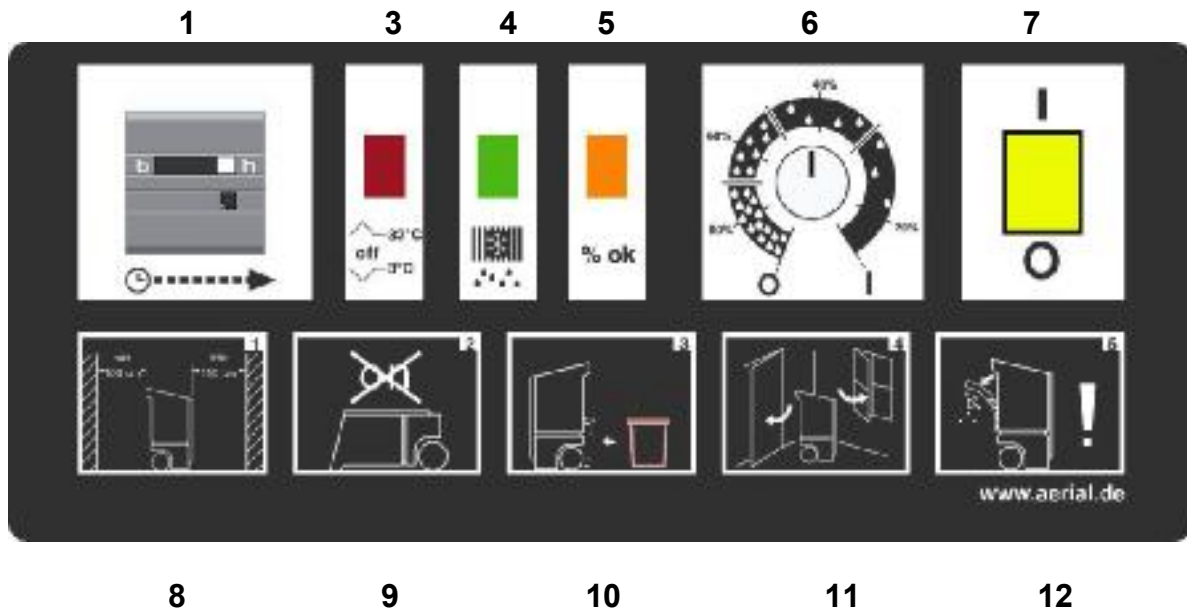

5.5 Description Operation panel

1 – Operation time counter

2 - **red neon** (at AD 740 / 750) = tank is full, unit has switched off.

3 - **red neon** (option) = ThermoLogic (opt. extra) has switched off. The “ThermoLogic” switches the unit off if the ambient temperature is higher / lower than the allowed working range. (> +32°C / < +3°C). As soon as the allowed temperature has reached, the unit switches on again automatically.

4 – **green neon** (standard) = Unit is in defrost mode. The compressor runs, the fan does not run. (hot-gas-defrosting)

5 - **orange neon** (standard) = The unit has switched off because the humidity in that room is ok / has achieved the requested value.

6 - **Hygrostat** (see 5.6 Hygrostat control)

7 - **On- / Off-Switch**

8 - Make sure a free space in front of air inlet / outlet!

9 - Don't switch on the unit in horizontal position

10 - Make sure that the condensate can drain off reliably into a sump or bucket.

11 - Close doors and windows while using the dryer

12 - Check and clean air filter regularly!

5.6 Hygrostat control

The air dryers of the AD-series dispose of a hygrostat for setting the required humidity value. This hygrostat is located in the operation panel. It makes that the air dryer cuts in as soon as the ambient humidity exceeds the preset value. If the humidity value falls below the set value, the hygrostat will switch off the unit.

Pos. 0 = Unit is switched off

Pos. 1 = Continues operation

80% = The dehumidifier switches off when a humidity of approx. 80% r.h. has achieved. And switches on again when humidity is higher than 80%.

60% = The dehumidifier switches off when a humidity of approx. 60% r.h. has achieved. And switches on again when humidity is higher than 60%.

40% = The dehumidifier switches off when a humidity of approx. 40% r.h. has achieved. And switches on again when humidity is higher than 40%.

20% = The dehumidifier switches off when a humidity of approx. 20% r.h. has achieved. And switches on again when humidity is higher than 20%.

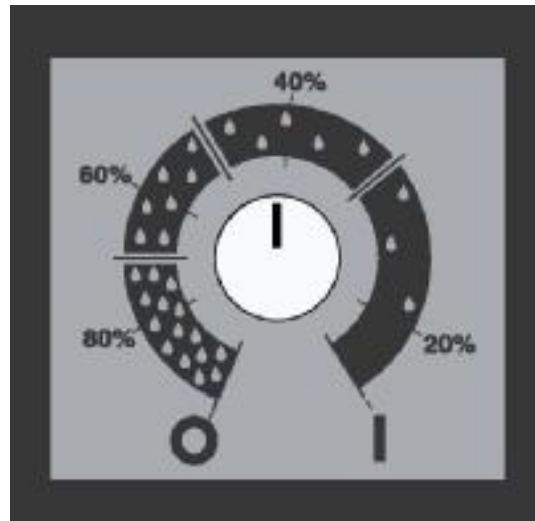

The smooth setting option of the hygostat makes a very convenient humidity control possible for you. If very precise values are requested, you should match the hygostat with the information on a precise hygrometer.

Please consider:

Humidity values of a minimum of 40 % - 45 % r.h. can be achieved with a condensation dryer. An adsorption dryer is to be employed if lower values are required.

For this purpose, ask your technical consultant.

Optimal climate:

For living rooms, environmental conditions of 20°-25°C and 50 - 60 % r.h. are recommended.

For building drying, the hygostat becomes turned at continues running (POS. I).

In the case of the drying rooms with wood equipment (e.g. floors) or paintings, antiques and similar things should not be fallen below a humidity of 55%.

Ask your technical consultant in the case of special applications.

External humidity control

We also deliver AD 7 optionally with connection option for an external On-/off-switch, e.g. through a dew point control or external hygostat.

In that case, the device is equipped with our SensorLogic which supplies a floating contact and a mains voltage of 24 V.

An Amphenol-socket is then in the operating tableau instead of the hygostat. With an Amphenol-plug (accessory), your external control can be connected very simply.

5.7 Condensate outlet AD 740 / AD 750

The dehumidifiers AD 740 / AD 750 are provided with a water collecting bucket (12 l) and a connection for hose 15 mm.

The water bucket is in the device on a balance. The balance is activated by the weight of the full bucket and the device is switched off. Switch off the unit at the on/off-switch and empty the bucket. After the bucket is placed in the device again, turn on the device at the on-/off-switch.

A connection outlet 15 mm is placed above the bucket. Remove the bucket provided that you would like to guide the condensate directly into a drain. Attach a hose to the drain 15 mm and secure this with a hose clamp. Proceed cautiously in order not to burst the drain from the condensate tub.

Guide the hose with slope of the device into the drain away (at least 5 cm per meters slope).

5.8 Condensate outlet AD 770 / AD 790

The air dryer AD 770 / 790 are serially equipped with fitting for 15 mm hoses. As an accessory, a water tank (25 ltr., optional extra) is available which is put under the device at the back. A piece of hose which is led into this bucket is already mounted.

ATTENTION:

Make sure that the condensate can always be handled safely.

The water tank at AD 770 / 790 (optional extra) does NOT disconnect the device in the case of full state. During unattended using, AD 770 / 790 with built-in pump is advisable.

5.9 Condensate pump (optional)

Optional the devices are available with built-in condensate pump. In that case, a connection piece is found at the back wall of the device for hose 12 mm.

A red pushbutton is also found at the back wall. In this way, the pump can be emptied manually, for example before transportation of the device.

We recommend the manual pumping out before transportation since otherwise water from the pump can run onto the ground while tilting the device.

5.10 Automatic defrosting

During air drying, ice may form at the evaporator. The volume of ice depends on the ambient conditions prevailing in the room to be dried. The air dryer is equipped with an automatic hot-gas defroster. It ensures that, depending on the extent of ice formation, the appliance will be defrosted automatically according to the following principle:

- A temperature sensor measures the condition existing in a critical area of the evaporator.
- It transmits the signal for defrosting to the DryLogic-electronic. The DryLogic finds out if defrosting is necessary, and it will start defrost-mode on its own.
- During defrosting the compressor works and the fan does not work.

When the ice is defrosted, the dehumidifier will start again with dehumidifying.

6. Operating conditions

AD-condensation dryers are suitable for the effort on construction sites, in residential buildings, in swimming halls, in garages and storerooms. AD-condensation dryers work problem-free at the temperature range of +3 to +32°C and in the case of relative humidity from 40% to 95% r.h. .

Optional the unit is deliverable with included ThermoLogic (opt. extra). In this way, the device turns off at inadmissible temperatures and on again at more permissibly temperatures automatically.

The use in rooms with higher temperatures leads to disadvantages at the compressor. The use in rooms with lower temperatures is ineffective and can lead to icing.

Also the storage of the dehumidifier at inadmissible temperature conditions can lead to damages / problems while immediate switch-on. Therefore, make possible short time for adaptation for the device before switch-on.

ATTENTION:

The appliance must not be used under the following conditions:

- *in rooms of potentially explosive atmosphere*
- *in rooms of aggressive atmospheres, for example ammonia and wood acid*
- *In rooms with water which shows a pH-value outside of 7,0 to 7,4. **Remark:** In the case of lower pH-value, corrosion occurs at all metals and damages occurs at mortar containing materials. In the case of higher pH-value, it comes to irritation of skin and eye mucous membrane and extreme lime deposits.*
- *In rooms with salt or salty liquids. Salt content > 1% (also sole baths).*
- *In rooms of air treated with ozone*
- *in rooms featuring a high concentration of solvents*
- *in rooms of an extremely high ratio of dust.*

In the case of doubtful operating conditions it is recommended to contact the Technical Department of Messrs. AERIAL or a specialized dealer.

Using an AD-air dryer under inadequate operating conditions will entail that the warranty becomes null and void.

7. Technical data

Among other things, many different components which are installed in the condensation dryer decide on the capacity of the device. Since these components can never be completely identical, in accordance to DIN EN 810 the capacity may deviate up to 5% of specified capacity.

General:

Operational range: +3°C up to + 32°C / 40% r.h. up to 95% r.h.
Protection class: IP 44
Voltage : 230 V / 50 Hz

Type		AD 740	AD 750	AD 770	AD 790
Air volume	cbm/h	710	710	900	1400
Power consumption	Max. Watt	800	900	1015	1700
Noise level	dB(A)	53	53	53	65
Refrigerant (charge see type plate)		R407c	R407c	R134a	R407c
Capacity / power consumption at					
30°C / 80%	l/24h Watt	42,0 800	55,0 900	70,8 1015	90,0 1700
27°C / 60%	l/24h Watt	26,8 700	34,1 780	44 840	58,3 1400
20°C / 60%	l/24h Watt	19,2 600	24,5 660	28,6 710	41,0 1150
10°C / 70%	l/24h Watt	11,0 500	14,0 560	17,5 558	20,0 950
dimensions	mm	880 x 520 x 495		1000 x 640 x 580	
weight	kg	40	42	55	61

8. Service & maintenance

ATTENTION

When performing any repair or maintenance, the general safety rules and provisions must be adhered to!

In order to guarantee a troublefree function of the dryer the device should be cleaned regularly. The following procedure is recommended:

- Switch OFF the air dryer
- Disconnect mains cable
- Remove filter holder
- Remove filter for cleaning or disposal
- Dismount front panel
- Blow out device cautiously with compressed air. (wear protective goggles!) In this case, it might ensure that all components are cleaned. (Compressor, evaporator, condenser, ect.)
- Check hose connector and connected hose
- Mount front panel
- Clean case with moist cloth. Do not use aggressive Detergent
- Insert new or cleaned filter, Insert filter holder
- Put main plug into the socket
- Switch on dehumidifier.

This cleaning is without fail regularly required!
During construction site effort, after every effort or once a week!

No other maintenance work is required for the air dryer.

9. Trouble shooting

Assign that dehumidifier a putative defect on, please, first check the following points. If this should provide no relief, please contact your technical consultant.

1) The dehumidifier shows a bad or no drying capacity

- The humidity is lower than 40% r.h. or the temperature in that room is lower than +3°C. The using of the dryer is uneconomical in the case of these conditions. It is recommended to disconnect the dryer. **Tipp:** Put the built-in hygostat on an attainable value (e.g. approx. 50%r.F.), with it the dryer punctually may switch off.
- The air filter is soiled. The dryer does not receive air sufficiently. Clean the filter and/or install a new one. A soiled air filter can in the long run lead to disadvantages at the dryer. **Tipp:** Control the filter regularly.

2) The fan of the dehumidifier does not work.

- The unit is in defrost mode. In this case the compressor still runs and the fan does not run. The red neon in the operation panel lights up. After some minutes, the unit will start with regular working.

3) The complete dryer is out of operation. Fan and compressor does not run.

- Is the dryer switched on? The On-/Off-switch must be in position 'I' and must light up.
- Is the unit supplied with voltage? The On/Off-switch must light up in Pos. 'I'. Check the main cable, an additional cable, the socket and the main fuse.
- The humidity value adjusted at the hygostat is achieved. The dryer will start again after exceeding the adjusted humidity.
- **Only at units with optional extra „ThermoLogic“** >>Thermostat switch off“<< (= red neon in the operation panel):
The ambient temperature in that room is lower than +3°C or higher than +32°C. The red neon lights up (see 5.3 / 5.4 / 5.5 „operation panel“). The unit will start again when the temperature in that room has achieved normal conditions between +3°C and +32°C.
- **Only at AD 740 / AD 750** >>water collecting bucket is full<< The red neon lights up (see 5.3 / 5.4 / 5.5 „operation panel“). Empty the water bucket and put it back into the unit. (see 5.7 „condensate outlet“)

4) Strong icing up at the evaporator.

- Put the dryer into a room with min. +10°C room temperature and wait until complete ice is defrosted. Switch on the unit again (in that room with min. +10°C) and let work for approx 3 hours. If there is icing up again, please contact your dealer. Otherwise make sure that the units is only been used in rooms with more than +3°C. Also the storage of the dehumidifier at inadmissible temperature conditions can lead to damages / problems while immediate switch-on.

5) The humidity adjusted at the hygrostat does not become achieved and/or the device does not switch off automatic.:

- Is the hygrostat adjusted on a value lower than 40 – 45% r.h.? Humidity values with a minimum of 40 % - 45 % r.h. can be achieved with a condensation dryer. Adjust the hygrostat to a reachable value.
- Is the unit with enough capacity for your application? The air changing, number of the persons in the room and open water surfaces decide on the humidity burden in the room. Let calculate the necessary capacity from your dealer
- Is there a lot of water in the walls or the floor? In that case the dryer needs some time to remove that water and to achieve an acceptable humidity in that room.

ATTENTION

The appliance must be repaired by trained and expert personnel only. In the case of interventions by unauthorized people, any and all warranty claims shall become null and void!

If you have any questions regarding defects and malfunctions of AERIAL-air dryers we recommend get in touch with your supplier.

The producer AERIAL GmbH you reach under 0049-40-526879-0 or www.aerial.de

10. Disposal

Please do not dispose this unit with the domestic waste and please do not dispose this unit in the environment.

We dispose this unit for you – free of charge and environment-friendly. Please contact us!

Alternative your local waste management enterprise takes this unit for environment-friendly disposal.

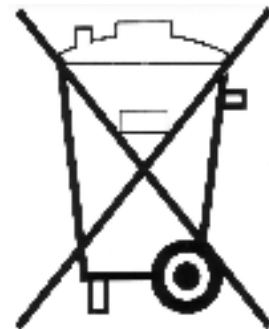

11.Circuit diagram

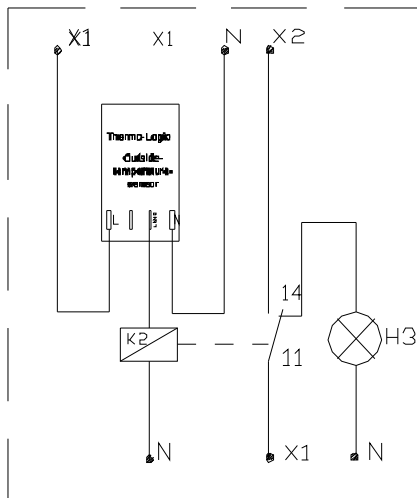
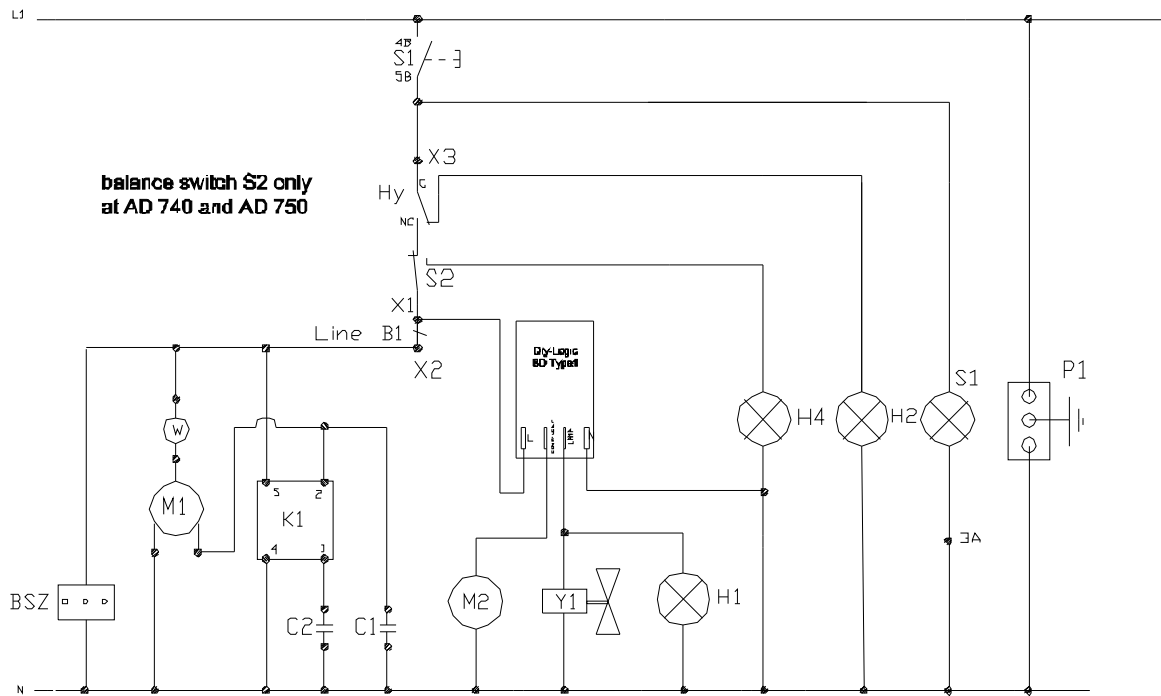

If ThermoLogic is installed, wire B1 is removed.

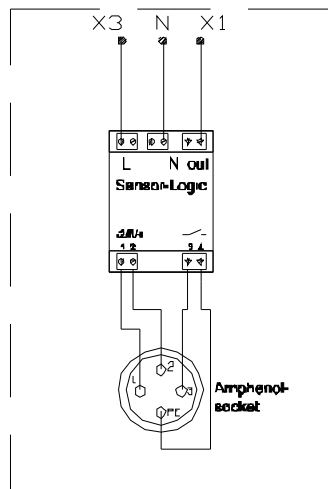

If SensorLogic is installed, no hygrostat is built in

- S1- On-/Off-switch
- S2- balance switch
- Hy- hygrostat
- BD- Dry Logic
- K1- switching relay
- K2- power relay
- C1- capacitor
- C2- capacitor
- M1- compressor
- M2- fan
- H1- defrost neon
- H2- hygrostat neon
- H3- <2°C >32°C neon
- H4- tank full neon
- Y1- magnetic valve
- P1- plug for pump
- BSZ- operation time counter

12. Manufacturer's declaration

(EU-directive 98/37/EG)
(EU-directive 2004/108/EG)
(EU-directive 73/23/EWG)

manufacturer: AERIAL GmbH - Systeme zur Luftbehandlung
Oststraße 128, D-22844 Norderstedt

Product description: dehumidifier type AD 740 / AD 750 /
AD 770 / AD 790

capacity: 42 - 90 l/day

The product described above is an ambient air dryer ready for connection.

Related standards: EN ISO 12100 Safety of Machinery
EN 50081-1/92 Electromagnetic Compatibility (EMC)
Basic Specification "Emitted
Interference"
EN 50082-1/97 Electromagnetic Compatibility (EMC)
Basic Specification "Emitted
Interference"
EN 60335-2-40/98 Safety of electric appliances for
domestic use and similar purposes

In the case of changings at the unit this manufacturer's declaration becomes void.

Norderstedt, 02.01.2008

sign / stamp

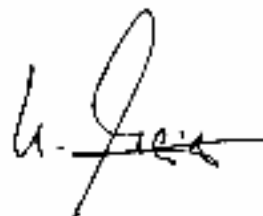

Karsten Meier – General Manager

AERIAL GmbH
Oststrasse 128
22844 Norderstedt
DEUTSCHLAND

Niederlassung Schweiz:
AERIAL GmbH
Täfernstrasse 20
5405 Baden-Dättwil
SCHWEIZ