

# **SILENSYS®**



Pièces de rechange - *Spare parts* - Ersatzteile  
*Piezas de repuesto* - Parti de ricambio



Tecumseh

Spare parts and accessories - Pièces de rechange et accessoires - Ersatzteile und Zuberhör  
Piezas de repuesto y accesorios - Parti de ricambio e accessori



S



R	SIL...	⚡	🔧	M	🔌		📊		🔌 F		🔌	🔌					
					A	B	A	B	Start	Run		Aux.					
R404A	SIL2432Z	F	CAJ 2432Z	csr	8 570 590	8 570 122	8 665 445	8 665 345	640 151	8 685 302	8 583 027	8 527 047	8 527 034	8 527 108			
	SIL2440Z	F	CAJ 2440Z	csr	8 570 590	8 570 122	8 665 445	8 665 345	640 155	8 685 302				8 527 109			
	SIL2446Z	F	CAJ 2446Z	csr	8 570 462		8 665 443	8 665 344	640 151	8 685 302				8 527 108			
		T	TAJ 2446Z	tri	8 682 305									8 527 109			
	SIL2464Z	F	CAJ 2464Z	csr	8 570 577		8 665 103	8 665 031	640 151	8 685 304				8 527 108			
		T	TAJ 2464Z	tri	8 682 306	8 682 483								8 527 109			
	SIL9450Z	F	CAE 9450Z	csr	8 570 364		8 665 102	8 665 027	640 153	8 685 301				8 583 026	8 527 047	8 527 034	8 527 108
	SIL9460Z	F	CAE 9460Z	csr	8 570 598		8 665 103	8 665 031	640 153	8 685 301							8 527 108
	SIL9480Z	F	CAJ 9480Z	csr	8 570 588	8 570 578	8 665 407	8 665 351	640 155	8 685 302				8 583 027	8 527 047	8 527 034	8 527 109
		T	TAJ 9480Z	tri	8 682 615	8 682 615											8 527 108
SIL9510Z	F	CAJ 9510Z	csr	8 570 289		8 665 443	8 665 344	640 157	8 685 302	8 583 027	8 527 047	8 527 034	8 527 109				
	T	TAJ 9510Z	tri	8 682 326	8 682 302								8 527 108				
SIL9513Z	F	CAJ 9513Z	csr	8 570 599	8 670 344	8 665 407	8 665 351	640 155	8 685 302	8 583 027	8 527 047	8 527 034	8 527 108				
	T	TAJ 9513Z	tri	8 682 306									8 527 109				
R134a	SIL4440Y	F	CAE 4440Y	csir	8 670 442		8 662 564	-	8 640 245		8 583 027	8 527 047	8 527 034	8 527 108			
	SIL4461Y	F	CAJ 4461Y	csir	8 570 076		8 662 585	620 210	640 154					8 527 109			
		T	TAJ 4461Y	tri	8 682 304									8 527 108			
	SIL4476Y	F	CAJ 4476Y	csir	8 570 588		8 662 584		640 150					8 527 109			
		F	CAJ 4492Y	csir	8 570 462		8 662 567	620 207	640 150					8 527 108			
	T	TAJ 4492Y	tri	8 682 326	8 682 302					8 527 109							
SIL4511Y	F	CAJ 4511Y	csr	8 570 582	8 572 050	8 665 103	8 665 031	640 155	8 685 302	8 583 027	8 527 047	8 527 034	8 527 108				
	T	TAJ 4511Y	tri	8 682 306									8 527 109				



Tecumseh

Spare parts and accessories - Pièces de rechange et accessoires - Ersatzteile und Zuberhör  
Piezas de repuesto y accesorios - Parti de ricambio e accessori



M



R	SIL...	⚡	🔧	Ⓜ	🔌		📊		🔌		🔌	🔌		
					A	B	A	B	Start	Run		Aux.		
R404A	SIL2480Z	F	FH 2480Z	csr			8 665 412	8 665 313	640 163	8 685 305	8 583 032	8 527 047	8 527 108	8 527 034
		K	TFH 2480Z	tri								8 527 042		
		T												
	SIL2511Z	F	FH 2511Z	csr			8 665 407	8 665 351	640 163	8 685 305	8 583 027	8 527 047		
		K	TFH 2511Z	tri								8 527 041		
		T										8 527 047		
	SIL4517Z	F	CAJ 4517Z	csr	8 570 619	8 570 380	8 665 102	8 665 027	640 157	8 685 303	8 583 027	8 527 042		
		T	TAJ 4517Z	tri	8 682 325									
	SIL4519Z	F	CAJ 4519Z	csr	8 672 105		8 665 400	8 665 305	8 640 244	8 685 307	8 583 027	8 527 042		
		T	TAJ 4519Z	tri	8 682 328	8 682 303						8 527 043		
	SIL4524Z	F	FH 4524Z	csr			8 665 407	8 665 351	640 157	8 685 306	8 583 032	8 527 042		
		K	TFH 4524Z	tri								8 527 042		
T										8 527 047				
SIL4531Z	F	FH 4531 Z	csr			8 665 103	8 665 031	640 163	8 685 307	8 583 032	8 527 042			
	K	TFH 4531 Z	tri								8 527 043			
	T										8 527 042			
SIL4540Z	F	FH 4540 Z	csr			8 665 103	8 665 031	640 163	8 685 309	8 583 032	8 527 042			
	K	TFH 4540 Z	tri								8 527 042			
	T										8 527 047			
R134a	SIL4518Y	F	FH 4518Y	csr			8 665 400	8 665 305	640 151	8 685 305	8 583 032	8 527 047		
		T	TFH 4518Y	tri								8 527 042		
	SIL4525Y	F	FH 4525Y	csr			8 665 102	8 665 027	640 156	8 685 306	8 583 032	8 527 041		
		K	FH 4525Y	csr								8 527 047		
		T	TFH 4525Y	tri										



Tecumseh

Spare parts and accessories - Pièces de rechange et accessoires - Ersatzteile und Zuberhör  
 Piezas de repuesto y accesorios - Parti de ricambio e accessori



L



R	SIL...												
					A	B	A	B			Start	Run	Aux.
R404A	SIL2516Z	K	TAG 2516Z	tri						8 527 041	8 527 108	8 527 034	
		T									8 527 047		8 527 109
	SIL2522Z	K	TAG 2522Z	tri						8 527 042	8 527 108		
		T									8 527 047		8 527 109
	SIL4546Z	K	TAG 4546Z	tri							8 527 042		8 527 108
		T									8 527 047		8 527 109
	SIL4553Z	K	TAG 4553Z	tri							8 527 043		8 527 102
		T									8 527 047		8 527 109
SIL4561Z	K	TAG 4561Z	tri							8 527 043	8 527 102		
	T									8 527 041	8 527 109		
SIL4568Z	K	TAG 4568Z	tri							8 527 043	8 527 102		
	T									8 527 042	8 527 109		
SIL4573Z	K	TAG 4573Z	tri							8 527 043	8 527 102		
	T									8 527 042	8 527 102		
R134a	SIL4528Y	K	TAG 4528Y	tri						8 527 042	8 527 109		
		T											8 527 047
	SIL4534Y	K	TAG 4534Y	tri									8 527 042
		T											8 527 047
	SIL4537Y	K	TAG 4537Y	tri									8 527 042
		T											8 527 047
	SIL4543Y	K	TAG 4543Y	tri									8 527 042
		T											8 527 047









Tecumseh



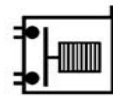

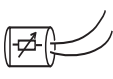









Spare parts and accessories - Pièces de rechange et accessoires - Ersatzteile und Zuberhör  
 Piezas de repuesto y accesorios - Parti de ricambio e accessori

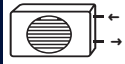













XL



R	SIL...	⚡	🔧	Ⓜ	 A B		 A B		 F  F Start Run			   Aux.		
R404A	SIL2532Z	T	TAGD2532Z	tri							8 583 032	8 527 047	8 527 103	8 527 034
	SIL2544Z	T	TAGD2544Z	tri								8 527 041		
	SIL4590Z	T	TAGD4590Z	tri								8 527 042		
	SIL4610Z	T	TAGD4610Z	tri										
	SIL4612Z	T	TAGD4612Z	tri										
	SIL4614Z	T	TAGD4614Z	tri										
R134a	SIL4556Y	T	TAGD4556Y	tri								8 527 047		
	SIL4568Y	T	TAGD4568Y	tri										
	SIL4574Y	T	TAGD4574Y	tri										
	SIL4586Y	T	TAGD4586Y	tri										

		SIL...																
	R404A	SIL2432Z	8 668 096	8 640 113	8 580 075	8 580 046	8 580 047	8 338 279	8 683 049	8 683 049	8 661 567	8 661 544	8 683 060	8 348 058	8 380 213			
		SIL2440Z											8 683 053	8 348 057	8 380 209			
		SIL2446Z											8 380 173	8 683 060	8 348 058	8 380 213		
		SIL2464Z											8 661 567	8 661 544	8 683 053	8 348 057	8 380 209	
		SIL9450Z											8 380 173	8 683 060	8 348 058	8 380 213		
		SIL9460Z											8 661 567	8 661 544	8 683 053	8 348 057	8 380 209	
		SIL9480Z											8 380 173	8 683 060	8 348 058	8 380 213		
		SIL9510Z											8 661 567	8 661 544	8 683 053	8 348 057	8 380 209	
	SIL9513Z	8 380 173			8 683 060			8 348 058	8 380 213									
	R134a	SIL4440Y			8 661 567			8 661 544	8 683 053		8 348 057	8 380 209						
		SIL4461Y			8 380 173			8 683 060	8 348 058		8 380 213							
		SIL4476Y			8 661 567			8 661 544										
		SIL4492Y																
		SIL4511Y																
	R404A	SIL2480Z	8 668 097	8 640 120	8 580 075	8 580 046	8 580 047	8 338 279	660 062	8 683 049	8 661 566	8 661 543	8 683 053	8 348 057	8 380 209			
		SIL2511Z						8 338 277					8 683 053	8 348 057	8 380 209			
		SIL4517Z						8 338 279					8 683 053	8 348 057	8 380 209			
		SIL4519Z						8 338 277					660 062	8 380 159	8 661 155	8 683 049	8 348 059	8 380 215
		SIL4524Z						8 338 277					660 062	8 661 566	8 661 543	8 683 053	8 348 057	8 380 209
		SIL4531Z						8 338 279					660 063	8 380 159	8 661 155	8 683 049	8 348 059	8 380 215
		SIL4540Z						8 338 278					660 063	8 661 566	8 661 543	8 683 053	8 348 057	8 380 209
	R134a	SIL4518Y			8 338 279			660 062	8 661 566	8 661 543	8 683 053	8 348 057	8 380 209					
		SIL4525Y			8 580 074													

	<b>R</b>	SIL...				 LP HP									
						Auto. Man.				Fusible					
<b>L</b>  	<b>R404A</b>	SIL2516Z	8 668 097	8 640 120	8 580 075		8 338 279	660 063	8 683 046	8 380 160	8 661 161	8 683 053	8 348 057	8 380 209	
		SIL2522Z													
		SIL4546Z													
		SIL4553Z													
		SIL4561Z													
		SIL4568Z													
	SIL4573Z														
	<b>R134a</b>	SIL4528Y	8 580 074	8 338 279	660 063	8 683 046	8 380 160	8 661 161	8 683 053	8 348 057	8 380 209				
		SIL4534Y													
		SIL4537Y													
SIL4543Y															
<b>XL</b>  	<b>R404A</b>	SIL2532Z	8 668 099	8 663 300	8 580 046	8 580 047	8 338280	660 064	8 380 090	8 380 157	8 661 150	8 683 059	8 348 060	8 380 216	
		SIL2544Z													
		SIL4590Z													
		SIL4610Z													
		SIL4612Z													
		SIL4614Z													
	SIL4615Z														
	<b>R134a</b>	SIL4556Y	8 663 301	8 338281	660 064	8 683 036	8 380 090	8 380 156	8 661 151	660 063	8 348 069	8 380 219			
		SIL4568Y													
		SIL4574Y													
SIL4586Y															

# " S "

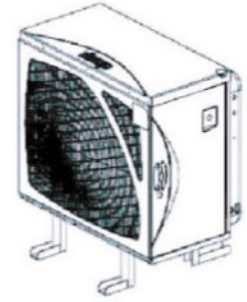

R404A

- SIL 2432 Z
- SIL 2440 Z
- SIL 2446 Z
- SIL 2464 Z
- SIL 9450 Z
- SIL 9460 Z
- SIL 9480 Z
- SIL 9510 Z
- SIL 9513 Z

R134a

- SIL 4440 Y
- SIL 4461 Y
- SIL 4476 Y
- SIL 4492 Y
- SIL 4511 Y

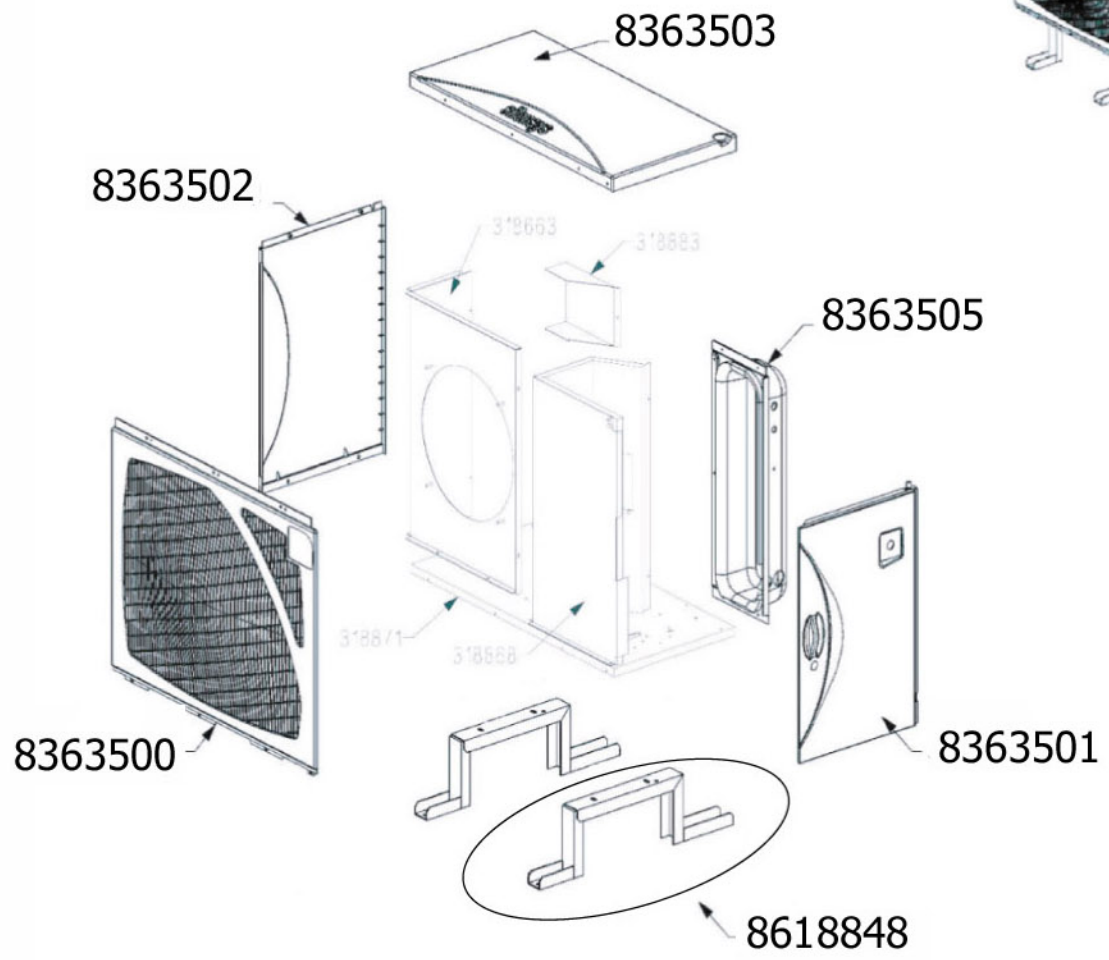

# " M "

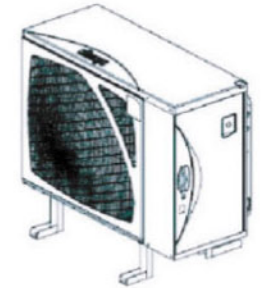

R404A

- SIL 2480 Z
- SIL 2511 Z
- SIL 4517 Z
- SIL 4519 Z
- SIL 4524 Z
- SIL 4531 Z
- SIL 4540 Z

R134a

- SIL 4518 Y
- SIL 4525 Y

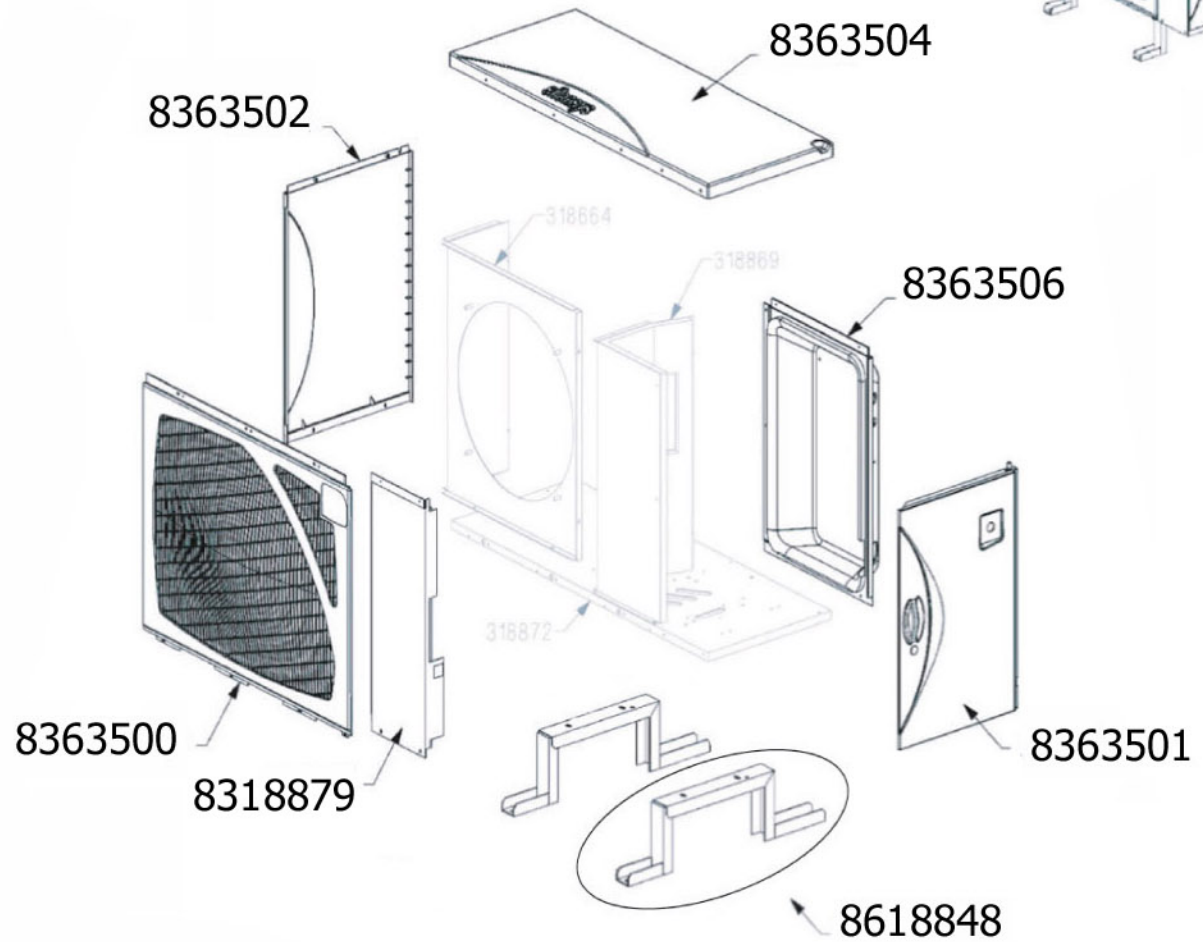

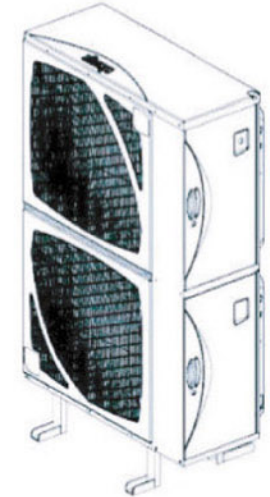

R404A

- SIL 2516 Z
- SIL 2522 Z
- SIL 4546 Z
- SIL 4553 Z
- SIL 4561 Z
- SIL 4568 Z
- SIL 4573 Z

R134a

- SIL 4528 Y
- SIL 4534 Y
- SIL 4537 Y
- SIL 4543 Y

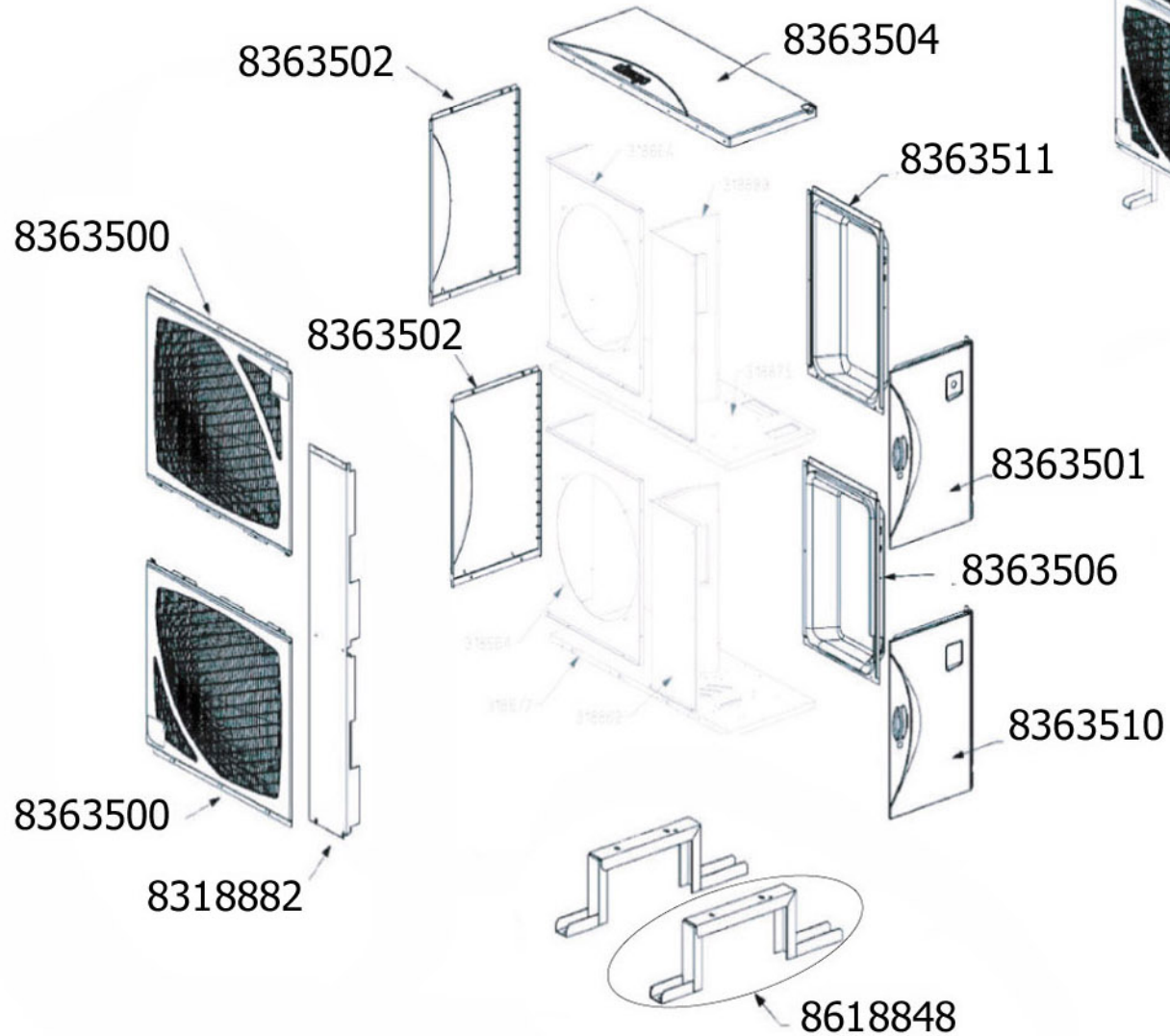

# " XL "

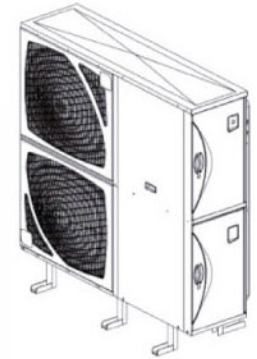

SIL 2532 Z

SIL 2544 Z

SIL 4590 Z

R404A SIL 4610 Z

SIL 4612 Z

SIL 4614 Z

SIL 4615 Z









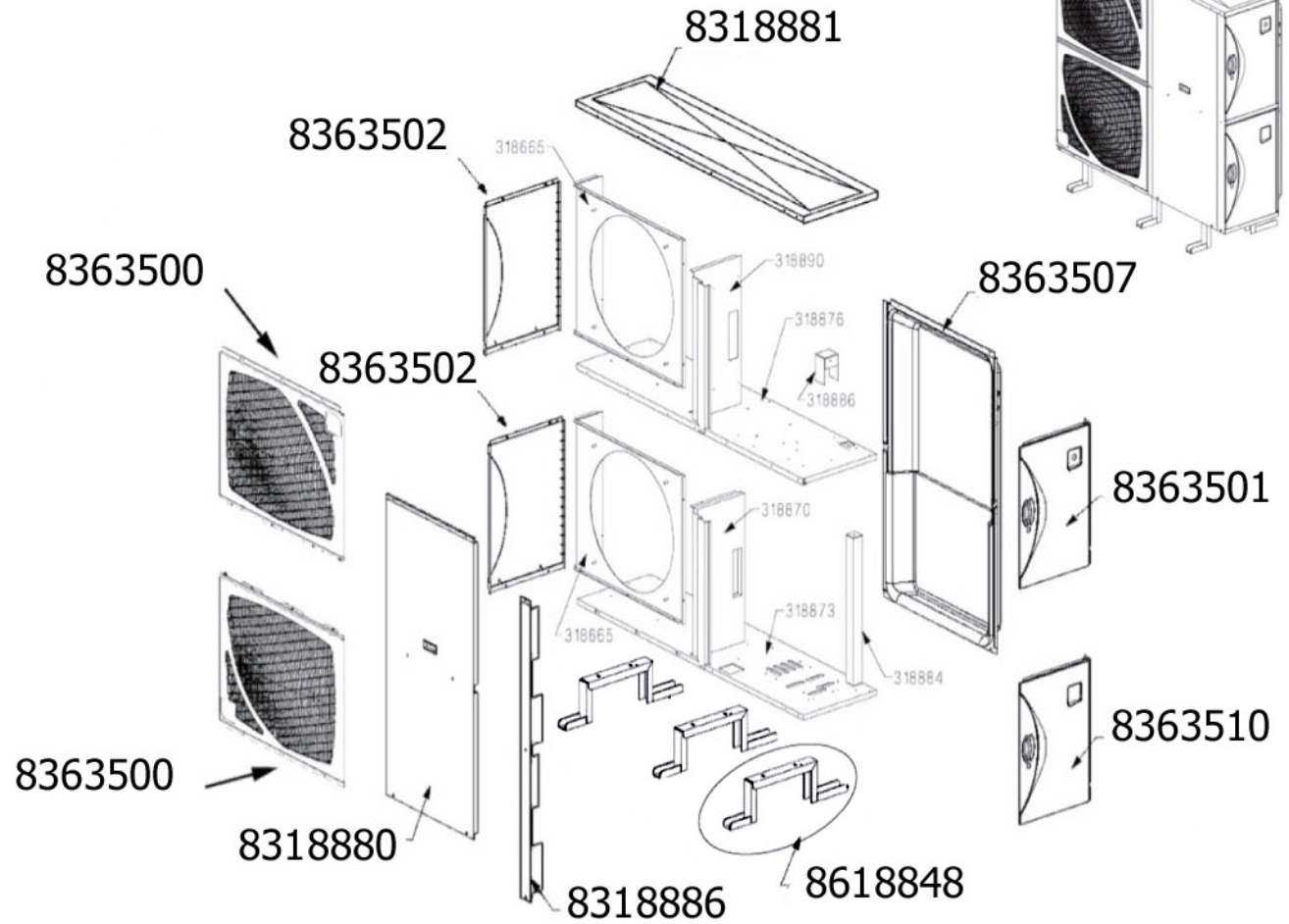









SIL 4556 Y

R134a SIL 4568 Y

SIL 4574 Y

SIL 4586 Y



	Français	English	Deutsch	Español	Italiano
	Fluide	Refrigerant	Kältemittel	Refrigerante	Refrigerante
<b>SIL...</b>	Modèle	Model	Modell	Modelo	Modello
	Tension	Voltage	Spannung	Voltaje	Tensione
	Compresseur	Compressor	Kompressor	Compresor	Compressori
	Type de moteur	Motor type	Motortypen	Tipodemotor	Caratteristiche del motor
	Protecteur	Overload	Motorschutzschalter	Protector	Protettore
	Relais	Relays	Relais	Relés	Relais
	Condensateur démarrage	Start capacitor	Anlaufkondensatoren	Condensador de arranque	Condensatore di spunto
	Condensateur permanent	Run capacitor	Betriebskondensatoren	Condensador permanent	Condensatore permanente
	Réchauffeur de carter	Crankcase heater	Kurbelwannenheizungen	Resistencias de cárter	Riscaldatore di carter
	Contacteur	Contacteur	Schalterschütz	Contacteur	Contattore
	Sectionneur	Isolator	Trennschalter	Seccionador	Sezionatore
	Contact auxiliaire	Auxiliary contact	Hilfskontakt	Contacteur auxiliair	Contatto ausiliare
	Ventilateur	Fan motor	Ventilator	Ventilador	Ventilatore
	Condensateur	Fan capacitor	Ventilator-kondensatoren	Condensador de ventilador	Condensatore
	Variateur de vitesse	Fan control	Geschwindigkeitsregelung	Variador de velocidad	Variatore di velocità
	Pressostat	Press.Switch	Druckschalter	Presostatos	Pressostato
	Condenseur	Condenser	Verflüssiger	Condensador	Condensatore
	Vanne Aspiration	Suction valve	Saugventil	Válvula de aspiración	Valvola di aspirazione
	Vanne Refoulement	Discharge valve	Druckventil	Válvula de impulsión	Valvola partenza
	Réservoir	Receiver	Sammler	Depósito	Ricevitore
	Vanne réservoir	Receiver valve	Sammlerventile	Válvula de Depósito	Valvola ricevitore
	Filtre deshydrateur	Filter drier	Filtertrockner	Filtro deshidratador	Filtro disidratore
	Voyant de liquide	Liquid indicator	Schauglas	Indicador de liquido	Spia del liquido